

For your safety, read carefully and keep in this vehicle.

2015 Infiniti

Navigation System Owner's Manual



INFINITI®

Owner's Manual Supplement

Revised INFINITI CONNECTION™ (if so equipped) trial subscription

The information contained within this supplement revises the INFINITI CONNECTION™ (if so equipped) trial subscription information in the following:

- 2015 Infiniti InTouch Owner's Manual – “INFINITI CONNECTION™ (if so equipped)” in the “Information and settings” section
- 2015MY Infiniti Navigation System Owner's Manual – “INFINITI CONNECTION™ (if so equipped)” in the “Viewing technical information” section
- 2016MY Infiniti Navigation System Owner's Manual – “INFINITI CONNECTION™ (if so equipped)” in the “Viewing technical information” section

Read carefully and keep in vehicle.

Printing: January 2016 (01)
Publication No. SU16EA 0NAVU0

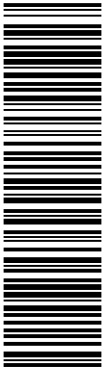

The referenced publications state that there is a complimentary 12 month trial subscription to the Infiniti Connection services. The complimentary trial subscription period as of January 1, 2016 is six months. However, please note that the availability and length of the complimentary trial period can change at any time in INFINITI's sole discretion. Please refer to <http://www.infiniti.com/intouch> or your INFINITI retailer for the most up-to-date information regarding the Infiniti Connection services complimentary trial period.

INFINITI NAVIGATION SYSTEM HELPDESK CONTACT INFORMATION

For assistance or inquiries about the INFINITI Navigation System, or to order updated map data, contact the INFINITI NAVIGATION SYSTEM HELPDESK at:

- ADDRESS: P.O. Box 1588 Orem, UT 84059-992
- E-MAIL: Infiniti-Navi-Info@navteq.com
- WEB SITE: www.InfinitiNavigation.com or www.infiniti.ca.
- PHONES: 1-800-777-0325
- HOURS: 6:00 AM to 5:00 PM (Pacific Time)

INFINITI CONSUMER AFFAIRS DEPARTMENT

For assistance or inquiries about the INFINITI warranty, service or general questions, contact the INFINITI Consumer Affairs Department at:

For U.S. customers

1-800-662-6200

For Canadian customers

1-800-361-4792

FOREWORD

Thank you for purchasing an INFINITI vehicle.

This user's manual is for the navigation system only. This manual contains operating instructions for the INFINITI Navigation System offered in your INFINITI vehicle.

Please read this manual carefully to ensure safe operation of the navigation system.

- Because of possible specification changes and optional equipment, sections of this manual may not apply to your vehicle.
- All information, specifications and illustrations in this manual are those in effect at the time of printing. INFINITI reserves the right to change specifications or design at any time without notice.
- Do not remove this manual from the vehicle when selling this vehicle. The next user of this navigation system may need the manual.

Table of Contents

1 Introduction

How to use this manual.....	1-2
Safety information	1-2
Laser product	1-3

2 Getting started

Control buttons and functions	2-2
Starting system	2-8
Navigation system status screen	2-9
Functions disabled while driving...	2-10
Menu screen and operation method	2-11
Touch panel operation	2-15
How to input letters and numbers	2-16
Map menu screen	2-18
Storing home location/address.....	2-20
Setting destination	2-21
Operating maps	2-24
Setting voice guidance	2-25
INFINITI voice recognition.....	2-27

3 Map settings

Map types	3-2
Displaying current vehicle location	3-4
Moving map	3-5
Changing scale of map	3-8
Changing map view	3-11
Map view settings	3-13
Looking at information on map.....	3-18

4 Setting destination

Destination screen	4-2
Delete destination	4-24

5 Route guidance

Procedures after setting destination.....	5-2
About route guidance	5-7
Route screen	5-13
Route guidance settings	5-27

6 Storing location/route

Storing location	6-2
Storing route	6-5
Storing tracked route.....	6-6
Storing avoid area	6-7
Editing address book.....	6-8
Deleting stored item	6-19
Transferring information to/from address book	6-22

7 Viewing technical information

Information screen.....	7-2
Infiniti Connection™ (if so equipped)	7-3
Viewing information about current vehicle location	7-15
Viewing available traffic information	7-16
Viewing available weather information	7-22
Map update	7-31

Viewing navigation system unit identification	7-32
Viewing navigation system version information.....	7-32
Viewing GPS current location information	7-32

8 Other settings

Settings screen.....	8-2
Display settings	8-3
Navigation setting	8-5
Volume adjustment.....	8-11
Clock settings.....	8-12
Language and unit settings	8-13

9 Voice recognition

INFINITI Voice Recognition.....	9-2
Standard mode.....	9-2
Alternate command mode	9-9
Command lists (Standard mode)....	9-20
Command Lists (Alternate command mode).....	9-23

10 General system information

Features of this navigation system	10-2
Current vehicle location	10-4
Route calculation	10-8
Route guidance.....	10-10
Notes on NavTraffic information...	10-14
Notes on NavWeatherXM information.....	10-15
Map data.....	10-16
How to handle display.....	10-21

11 Troubleshooting guide

Customer assistance.....	11-2
Basic operations.....	11-3
Vehicle icon	11-4
Route calculation and visual guidance	11-6
Voice guidance	11-8
Infiniti Connection™ (if so equipped)	11-9

Voice recognition	11-10
Traffic information	11-11

1 Introduction

How to use this manual.....	1-2	Safety information	1-2
For safe operation	1-2	Laser product	1-3
Reference symbols	1-2		



1. Introduction

HOW TO USE THIS MANUAL

This manual uses special words, symbols and icons that are organized by function.

Please refer to the following items to understand how to use this manual properly.

FOR SAFE OPERATION



WARNING

Indicates the presence of a hazard that could cause death or serious personal injury. To avoid or reduce the risk, the procedures must be followed precisely.



CAUTION

Indicates the presence of a hazard that could cause minor or moderate personal injury or damage to your vehicle. To avoid or reduce the risk, the procedures must be followed carefully.



NOTE:

Indicates items that help you understand and maximize the performance of your vehicle. If ignored, they may lead to a malfunction or poor performance.

REFERENCE SYMBOLS



INFO:

Indicates information that is necessary for efficient use of your vehicle or accessories.



Reference page:

Indicates the title and page that you should refer to.

<>:

Indicates a button on the control panel and steering wheel.

[]:

Indicates a key/item displayed on the screen.



Voice Command:

Indicates an operation by voice command.

Variable commands, such as numbers, are indicated in *italics* in angle brackets < >.

SAFETY INFORMATION

This system is primarily designed to help you reach your destination, and it also performs other functions as outlined in this manual. However, you, the driver, must use the system safely and properly. Information concerning road conditions, traffic signs and the availability of services may not always be up to date. The system is not a substitute for safe, proper and legal driving.

Before using the navigation system, please read the following safety information. Always use the system as outlined in this manual.



WARNING

- To operate the navigation system or use the INFINITI controller, first park the vehicle in a safe location and set the parking brake. Operating the system while driving can distract the driver and may result in a serious accident.
- Do not rely on route guidance alone. Always be sure that all driving maneuvers are legal and safe in order to avoid accidents.

- Do not disassemble or modify this system. If you do, it may result in accidents, fire or electrical shock.
- If you notice any foreign objects in the system hardware, spill liquid on the system or notice smoke or a smell coming from it, stop using the system immediately and contact an INFINITI retailer. Ignoring such conditions may lead to accidents, fire or electrical shock.



CAUTION

- Do not use this system if you notice any malfunctions such as a frozen screen or the lack of sound. Continued use of the system may result in accidents, fire or electrical shock.
- Some jurisdictions may have laws limiting the use of video screens while driving. Use this system only where it is legal to do so.
- Extreme temperature conditions [below -4°F (-20°C) and above 158°F (70°C)] could affect the performance of the system.

- The glass display screen may break if it is hit with a hard or sharp object. If the glass screen breaks, do not touch it. Doing so could result in an injury.



NOTE:

Do not keep the navigation system running with the engine or the hybrid system stopped. Doing so may discharge the vehicle battery (12V battery). When you use the navigation system, always keep the engine or the hybrid system running.

LASER PRODUCT

This navigation system is certified as a Class 1 laser product.

The navigation system complies with DHHS Rules 21 CFR Chapter 1, Subchapter J.



WARNING

- Do not disassemble or modify this system. There are no user serviceable parts in this navigation system.
- If maintenance, adjustments and operations other than those specified in this manual are attempted, injury due to laser radiation and exposure could occur.

Nav
TRAFFIC

Required SiriusXM Satellite Radio and NavTraffic monthly subscriptions are sold separately. NavTraffic are only available in select markets. For more information, see www.siriusxm.com/navtraffic.

1. Introduction



Required SiriusXM Satellite Radio and NavWeatherXM monthly subscriptions are sold separately. NavWeatherXM is only available in select markets. For more information,

see www.siriusxm.com/navweather.

2 Getting started

Control buttons and functions	2-2	Map menu screen	2-18
Control panel (Type A)	2-2	Current location map screen	2-18
Control panel (Type B)	2-3	Scrolled location map screen	2-19
Control Panel (Type C)	2-5	Storing home location/address	2-20
INFINITI controller	2-6	How to store home location	2-20
Steering wheel switches	2-7	Setting destination	2-21
Starting system	2-8	Searching for destinations	2-21
Navigation system status screen	2-9	Starting route guidance	2-22
Functions disabled while driving	2-10	Canceling route	2-23
Touch screen operation	2-11	Operating maps	2-24
Menu screen and operation method	2-11	How to view map screen	2-24
Menu screens and their purposes	2-11	Setting voice guidance	2-25
Using controls to adjust values, levels, etc.	2-12	Turning voice guidance ON/OFF	2-25
Start menu	2-13	Adjusting voice guidance volume	2-25
List screen	2-14	INFINITI voice recognition	2-27
Touch panel operation	2-15	Using voice recognition system	2-27
Example of touch panel operation	2-15	Before starting	2-27
How to input letters and numbers	2-16	Giving voice commands	2-28
Character (letters and numbers)		Voice command examples	2-29
input screen	2-16	Command lists	2-33
Number input screen	2-17		

2. Getting started

CONTROL BUTTONS AND FUNCTIONS

Designs and button layout may vary depending on the specifications and the model.

CONTROL PANEL (Type A)

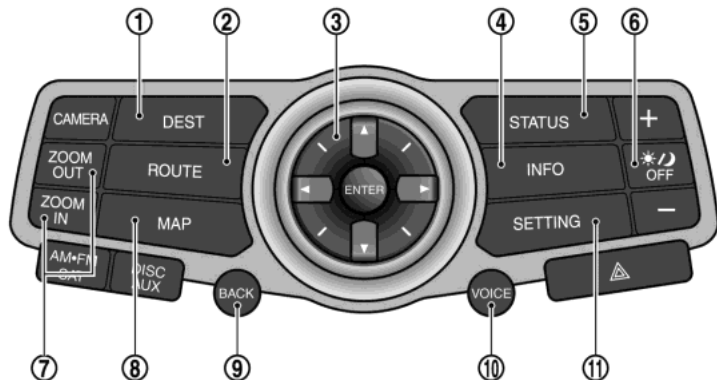

① <DEST>

Push to enter a destination. Various methods for entering a destination are available.

“4. Setting destination”

② <ROUTE>

Push to access the guidance control functions (guidance cancellation, route priority, waypoint setting on the route, etc.).

“5. Route guidance”

③ INFINITI controller:

Turn to highlight an item on the screen, and push <ENTER> to select the highlighted item.

On the map screen, turn to adjust the map scale.

To scroll the map, push the controller in the direction you want to scroll.

“INFINITI controller” (page 2-6)

④ <INFO>

Push to display the vehicle, traffic, weather or voice recognition information.

“7. Viewing technical information”

⑤ <STATUS>

Push multiple times to display audio information with either the air conditioner status, fuel economy or navigation directions.

⑥ <DAY/NIGHT OFF >

Push to switch between the day screen (bright) and the night screen (dark). Push and hold to turn off the display. Push again to turn on the display.

⑦ <ZOOM IN>, <ZOOM OUT>:

Push to adjust the map scale.

⑧ <MAP>:

Push to display the map. While following a programmed route, push multiple times to change the type of route information displayed.

⑨ <BACK>:

Push to return to the previous screen. In a settings screen, this button is also used to apply the setting.

In a character input screen, this button is also used to delete the characters that have been entered.

⑩ <VOICE>:

Push to hear the current guidance for a programmed route.

⑪ <SETTING>:

Push to access the system settings.

 "8. Other settings"



INFO:

- If <BACK> needs to be pushed to apply the setting on a settings screen, this manual will explicitly include a step for this procedure. Otherwise, pushing <BACK> returns

the display to the previous screen.

- The layout of the control panel switches may vary depending on the vehicle model and equipment.

CONTROL PANEL (Type B)

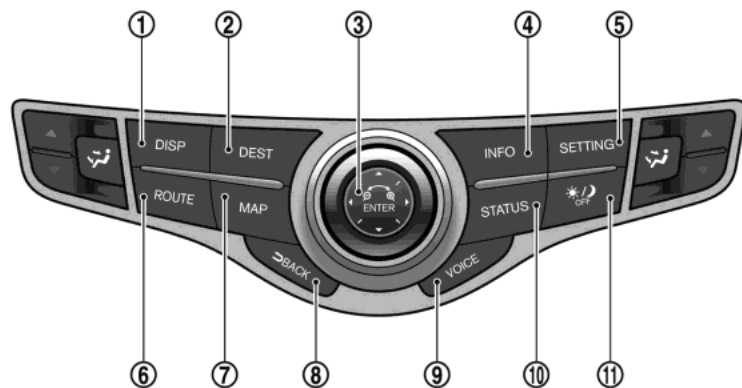

① <DISP> (without Around View Monitor):

Push to access the display settings.

<CAMERA> (with Around View Monitor):

Push to operate the Around View Monitor.

② <DEST>:

Push to enter a destination. Various methods for entering a destination are available.

 "4. Setting destination"

2. Getting started

③ INFINITI controller:

Slide or rotate to highlight an item on the screen, and push **<ENTER>** to select the highlighted item.

On the map screen, turn to adjust the map scale.

To scroll the map, slide the controller in the direction you want to scroll.

 “INFINITI controller” (page 2-6)

④ <INFO>:

Push to display the vehicle, traffic, weather or voice recognition information.

 “7. Viewing technical information”

⑤ <SETTING>:

Push to access the system settings.

 “8. Other settings”

⑥ <ROUTE>:

Push to access the guidance control functions (guidance cancellation, route priority, waypoint setting on the route, etc.).

 “5. Route guidance”

⑦ <MAP>:

Push to display the map. While following a programmed route, push multi-

ple times to change the type of route information displayed.

⑧ <BACK>:

Push to return to the previous screen. In a settings screen, this button is also used to apply the setting.

In a character input screen, this button is also used to delete the characters that have been entered.

⑨ <VOICE>:

Push to hear the current guidance for a programmed route.

⑩ <STATUS>:

Push multiple times to display audio information with either the air conditioner status, fuel economy or navigation directions.

⑪ <DAY/NIGHT OFF >:

Push to switch between the day screen (bright) and the night screen (dark). Push and hold to turn off the display. Push again to turn on the display.

INFO:

- If **<BACK>** needs to be pushed to apply the setting on a settings screen, this manual will explicitly include a step for this procedure. Otherwise, pushing **<BACK>** returns the display to the previous screen.
- The layout of the control panel switches may vary depending on the vehicle model and equipment.

CONTROL PANEL (Type C)

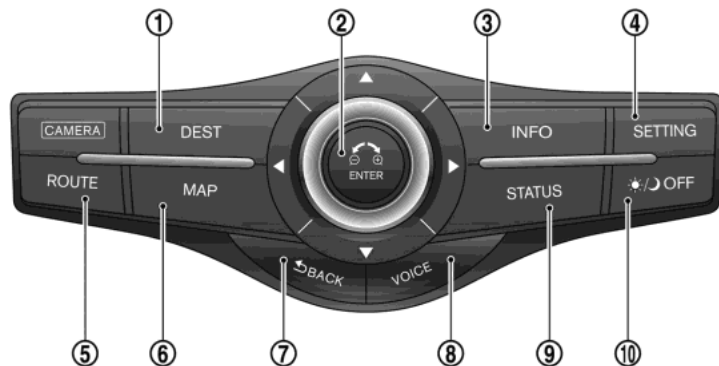

① <DEST>:

Push to enter a destination. Various methods for entering a destination are available.

☞ “4. Setting destination”

② INFINITI controller:

Slide or rotate to highlight an item on the screen, and push <ENTER> to select the highlighted item.

On the map screen, turn to adjust the map scale.

To scroll the map, slide the INFINITI controller in the direction you want to scroll.

☞ “INFINITI controller” (page 2-6)

③ <INFO>:

Push to display the vehicle, traffic, weather or voice recognition information.

☞ “7. Viewing technical information”

④ <SETTING>:

Push to access the system settings.

☞ “8. Other settings”

⑤ <ROUTE>:

Push to access the guidance control functions (guidance cancellation, route priority, waypoint setting on the route, etc.).

☞ “5. Route guidance”

⑥ <MAP>:

Push to display the map. While following a programmed route, push multiple times to change the type of route information displayed.

⑦ <BACK>:

Push to return to the previous screen. In a settings screen, this button is also used to apply the setting.

In a character input screen, this button is also used to delete the characters that have been entered.

⑧ <VOICE>:

Push to hear the current guidance for a programmed route.

⑨ <STATUS>:

Push multiple times to display audio information with either the air condi-

2. Getting started

tioner status, fuel economy or navigation directions.

⑩ <DAY/NIGHT OFF ☀/🌙 OFF>:

Push to switch between the day screen (bright) and the night screen (dark). Push and hold to turn off the display. Push again to turn on the display.



INFO:

- If <BACK> needs to be pushed to apply the setting on a settings screen, this manual will explicitly include a step for this procedure. Otherwise, pushing <BACK> returns the display to the previous screen.
- The layout of the control panel switches may vary depending on the vehicle model and equipment.

INFINITI CONTROLLER

With Directional buttons

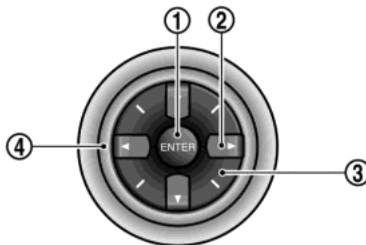

① <ENTER>:

Push to select the highlighted item on the screen.

If this button is pushed while a map is displayed, the map menu screen is displayed.

② Main directional buttons:

Use to move across the map, highlight an item on the screen or adjust a setting (volume, brightness, etc.).

③ Additional directional buttons:

Use to move across the map or highlight an item on the character input screen.

④ Center dial:

Turn to highlight an item on the screen or adjust a setting.

The center dial can also be used to adjust the map scale.

Without Directional buttons

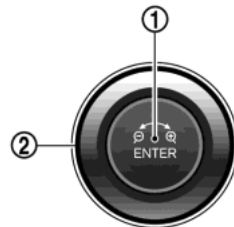

① <ENTER>:

Push to select the highlighted item on the screen.

If this button is pushed while a map is displayed, the map menu screen is displayed.

② Center dial/Slide switch:

Center dial

Turn to highlight an item on the screen or adjust a setting.

The center dial can also be used to adjust the map scale.

Slide switch

Slide (push upward/downward/leftward/rightward) to select an item on the screen or to adjust a setting (volume, brightness, etc.).

The map can be scrolled in 8 directions by sliding this switch.

STEERING WHEEL SWITCHES

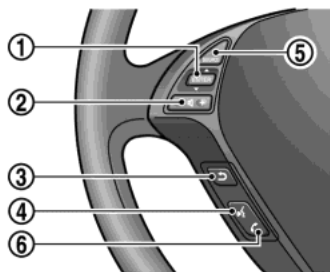

Type A

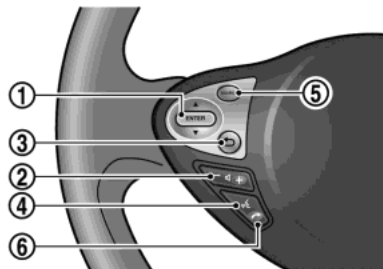

Type B

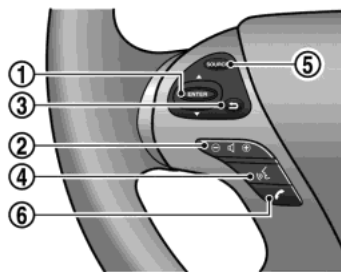

Type C

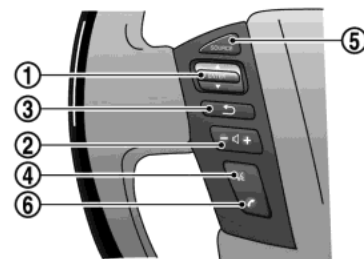

Type D

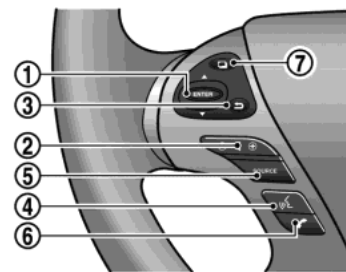

Type E

① <ENTER>:

Tilt to highlight an item on the screen or adjust a setting. Push to select the highlighted item.

If this button is pushed while a map is displayed, the map menu screen is

2. Getting started

displayed.

 “Map menu screen” (page 2-18)

Push and hold while a map or status screen is shown to display the Start Menu.

 “Start menu” (page 2-13)

If this button is tilted up while the audio function is activated and the map or status screen is displayed, the audio system can be operated.

②  :

Use to adjust the volume. These buttons have the same function as that of the volume control knob. Refer to the vehicle Owner’s Manual.

③ **<BACK**  **>**:

Push this button during a setting operation to return to the previous screen. In a settings screen, this button can also be used to apply the setting.

④ **<TALK**  **>**:

Push to start the voice recognition system. If the voice recognition system is already activated, pushing this button cancels the voice guidance and a voice command can be spoken

immediately.

⑤ **<SOURCE>**:

Use to switch the audio mode (source). Refer to the vehicle Owner’s Manual.

⑥  **>**:

Push to display the phone mode screen.

Refer to the vehicle Owner’s Manual.

⑦  **>**:

Push to change what is shown on the vehicle information display.

Refer to the vehicle Owner’s Manual.

STARTING SYSTEM

The navigation system starts when the ignition switch is turned to the ACC or ON position.

 **NOTE:**

Do not keep the navigation system on with the engine or the hybrid system stopped. Doing so may discharge the vehicle battery (12V battery). When you use the navigation system, always keep the engine or the hybrid system running.

NAVIGATION SYSTEM STATUS SCREEN

By pushing **<STATUS>** at any time, a split screen with audio information that is always at the top can be displayed.

Each time **<STATUS>** is pushed, the bottom part of the screen changes between air conditioner, fuel economy and navigation directions.



INFO:

There are different status screens displayed depending on various factors, such as the currently active mode, whether a destination has been set or not, etc.



When a route to the destination is set and the audio system is on, a screen similar to the one

above appears.

- ① Turning direction at the next intersection
- ② Name of the next street
- ③ Distance to the next intersection
- ④ Distance remaining to the destination
- ⑤ Remaining time to the destination

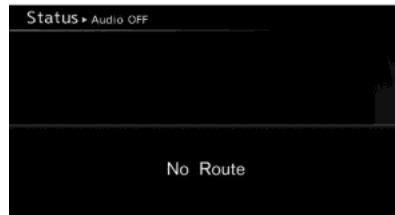

When a route to the destination is not set and the audio system is off, a screen similar to the one above appears.

2. Getting started

FUNCTIONS DISABLED WHILE DRIVING

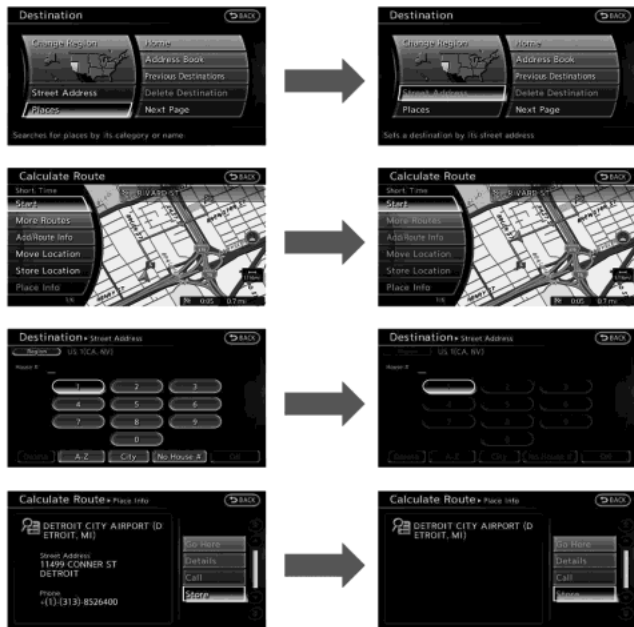

To ensure safe driving, some functions cannot be operated or have limited operation when the vehicle driving speed is above 5 MPH (8 km/h).

The on-screen text and keys for these restricted functions will be "grayed-out" or muted and cannot be selected while driving. In some cases, a screen message will appear indicating a restricted function.

Restricted functions while driving include:

- Character (letter and number) input screen during destination entry (street address, phone number, freeway entrance/exit, intersection, city center)
- Places search by name and city name
- Scrolling and viewing of certain navigation lists
- Adding/editing address book entries
- Adding/editing home location
- Storing current position, information, destinations

These functions will become available again when the vehicle speed is reduced to 5 MPH (8 km/h).

Destination functions available while driving include:

- Home
- Address Book
- Previous Destinations
- Nearby places
- My places
- Map input

TOUCH SCREEN OPERATION

The same operations described for the scrolling dial are possible using touch screen operation.

MENU SCREEN AND OPERATION METHOD

MENU SCREENS AND THEIR PURPOSES

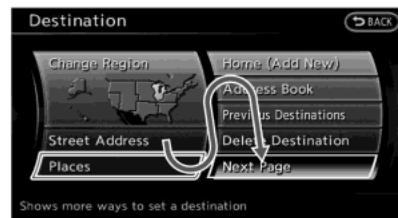

Push **<DEST>**, **<ROUTE>**, **<INFO>** or **<SETTING>** to display the corresponding menu screen.

How to select menu item

Example: **<DEST>** screen

1. Highlight the preferred menu item using the INFINITI controller.

2. To select the highlighted menu item, push **<ENTER>**. The next screen is displayed.
3. Push **<BACK>** to return to the previous screen.

Push **<MAP>** to return to the current location map screen.

2. Getting started

INFO:

An item can also be selected by tilting **<ENTER>** on the steering wheel up and down, and then pushing **<ENTER>**.

USING CONTROLS TO ADJUST VALUES, LEVELS, ETC.

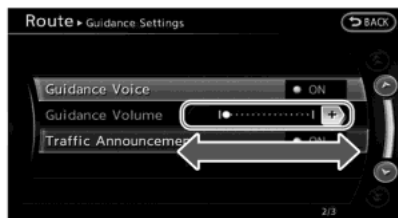
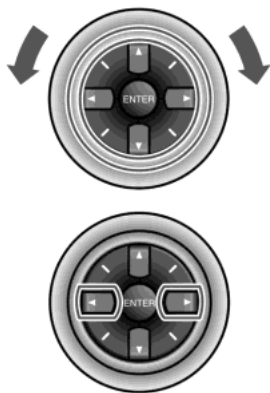

With directional buttons

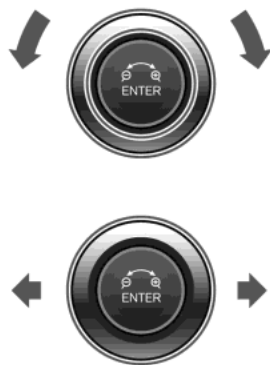

Without directional buttons

There are five main methods to control the navigation system: the center dial, the main directional buttons, the slide switch, the touch panel and the switches on the steering wheel. Use these controls to adjust the volume of the phone and voice guidance, the display brightness, etc.

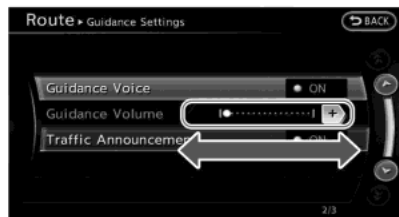

How to adjust

1. Highlight the preferred setting item and push **<ENTER>**. The color of the corresponding adjustment item changes.
2. Adjust the value or level indicating bar using the INFINITI controller.
3. Push **<ENTER>** or **<BACK>** to apply the setting.

INFO:

- The volume of phone and voice guidance, the display brightness, etc. can be adjusted by tilting **<ENTER>** on the steering wheel up and down.
- These same adjustments can also be performed using the touch panel operation.
 “Adjusting volume and others” (page 2-15)

START MENU

The start menu can be displayed using the switches on the steering wheel.



1. Push and hold **<ENTER>** on the steering wheel.
2. Highlight the preferred item and push **<ENTER>**.

2. Getting started



INFO:

<ENTER> on the steering wheel can be used to display the start menu only when the map or status screen is displayed.

Available setting items

- [Destination]:
Displays the destination screen. It is the same screen that appears when **<DEST>** is pushed.
☞ “4. Setting destination”
- [Route]:
Displays the route screen. It is the same screen that appears when **<ROUTE>** is pushed.
☞ “5. Route guidance”
- [Info]:
Displays the information screen. It is the same screen that appears when **<INFO>** is pushed.
☞ “7. Viewing technical information”
- [Settings]:
Displays the settings screen. It is the same screen that appears when **<SETTING>** is pushed.
☞ “8. Other settings”

LIST SCREEN

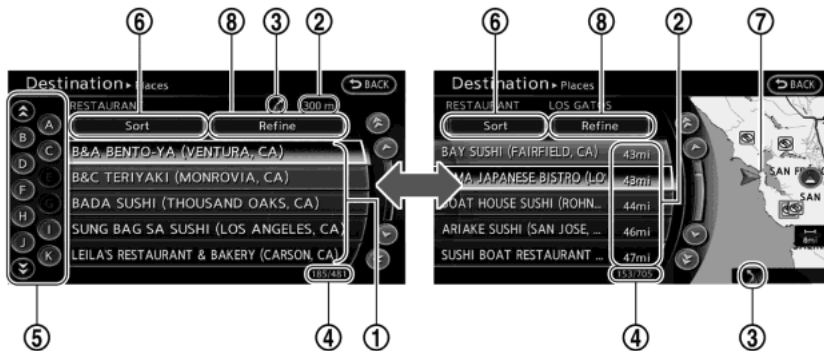

After searching for a point of interest, a list screen is displayed.

Depending on the list displayed, it can be sorted.

Items displayed in list

- ① Highlight the preferred item from the list and push **<ENTER>** to select it. If a location or facility name is not completely displayed (due to length), highlight the item to display the hidden

part of the name.

- ② Distance from the current location
- ③ Direction to the point of interest
- ④ If the entire list cannot be displayed on the screen, the system displays the total number of items in the list and the entry number of the selected item. Scroll the list using the INFINITI controller.

- The list will automatically scroll to the section of the list that begins with the letter selected.



INFO:

This feature is only available when the list is sorted by name and is not active for all lists.

- Highlight and push **<ENTER>** to select the other sort options.
- When the list is sorted by the shortest distance, the selected location can be confirmed in the preview displayed on the right side of the screen.
- Highlight and push **<ENTER>** to modify the search conditions.

TOUCH PANEL OPERATION

With this system, it is possible to use the INFINITI controller and touch panel operation to perform the same operations.

This manual describes the operations using the INFINITI controller.

For the operations that differ from those of the INFINITI controller and for useful methods for using the touch panel operation, refer to each section.

EXAMPLE OF TOUCH PANEL OPERATION

Examples of operations performed using the touch panel operation are described here.

Selecting item



When the item is touched, the next screen is displayed.

Adjusting volume and others

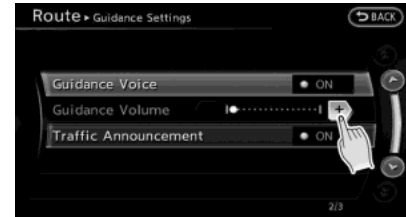

Touch **[+]** or **[-]** located on the right and left of the bar graph to perform the adjustment.

Scrolling a list or message



Touch **[↑]** or **[↓]** to scroll the list or message.

Touch **[↶]** or **[↷]** to skip to the next page.

2. Getting started

Inputting letters and numbers



1. Touch the letter or number.
2. Touch [Delete] to delete a character. Push and hold [Delete] to delete all of the characters.

HOW TO INPUT LETTERS AND NUMBERS

CHARACTER (letters and numbers) INPUT SCREEN

Alphanumeric characters are entered to set a destination, search for a facility, edit stored locations, etc.



1. Use the INFINITI controller to highlight a character on the displayed keyboard.



2. Push <ENTER>. The highlighted character is entered.

INFO:

Inputting letters can also be done with the touch panel operation.



3. Push <BACK>, or highlight [Delete] and push <ENTER> to delete the last character entered.

Push and hold <BACK> to delete all the characters entered.

Highlight [Space] and push <ENTER> to enter a space.



- After finishing the entry, highlight [List] and push **ENTER**.



INFO:

- Push **BACK** on the control panel to return to the previous screen, but only after deleting all the characters entered.
- Touch [BACK] on the screen to return to the previous screen even when characters have been entered.
- The list screen appears automatically when text has been entered and the matching list items have been narrowed down to a number that will fit on the screen.



Symbol input screen

- Symbol keys are displayed by highlighting [Symbols] and pushing **ENTER**. Alphabet keys are displayed by highlighting [A-Z] and pushing **ENTER**.

NUMBER INPUT SCREEN

A phone number or a street number can also be entered as a search method to look for a destination. Perform the following procedure to enter a number.



INFO:

Only the locations included in the map data database can be searched for by a phone number.



- Use the INFINITI controller to highlight a number on the displayed keyboard.



- Push **ENTER**. The highlighted number is entered.



INFO:

Inputting numbers can also be done with the touch panel operation.

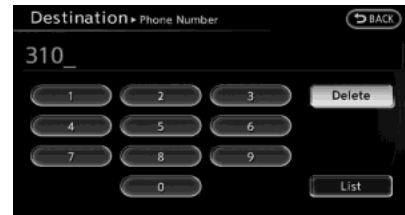

- Push **BACK**, or highlight [Delete] and push **ENTER** to delete the last number entered.

Push and hold **BACK** to delete all the numbers entered.

2. Getting started



4. After finishing the entry, highlight [List] and push **<ENTER>**.

INFO:

- Push **<BACK>** on the control panel to return to the previous screen, but only after deleting all the numbers entered.
- Touch [BACK] on the screen to return to the previous screen even when numbers have been entered.

MAP MENU SCREEN

Push **<ENTER>** while the current location map screen or a scrolled map screen is displayed to display the menu corresponding to that screen.

This menu can be used to access helpful functions quickly, such as setting a destination and searching for points of interest nearby.

There are various methods used to select a menu item. Use a method described earlier in this manual.

 “Menu screen and operation method” (page 2-11)



INFO:

With the touch panel operation, the same screen can be displayed by touching [Map Menu] located on the map screen.

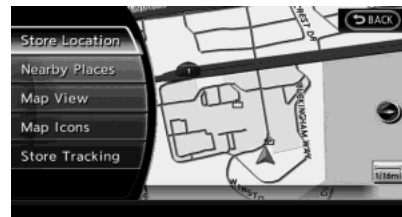

CURRENT LOCATION MAP SCREEN



If **<ENTER>** is pushed while the current location map screen is displayed, the following options are available.

- [Store Location]:
Stores the current vehicle location in the Address Book. The stored location can be retrieved as necessary to set it as a destination (waypoint).
 “Storing location” (page 6-2)
- [Nearby Places]:
Searches for points of interest near the current vehicle location, such as restaurants and gas stations, etc.
 “Finding nearby place” (page 4-6)
- [Map View]:
Performs map operations such as the switching of map type and the setting of map orientation and scale.



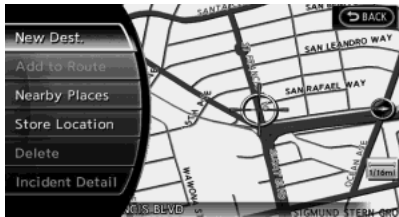

“3. Map settings”

- [Map Icons]:
Displays map icons of certain points of interest (such as restaurants and gas stations, etc.) on the map around the current vehicle location.
 “Displaying map icons”
(page 3-18)
- [Store Tracking]:
Stores in the Address Book the route travelled from the starting point to the current location.
 “Storing tracked route” (page 6-6)

SCROLLED LOCATION MAP SCREEN



If **<ENTER>** is pushed while a scrolled map screen is displayed, the following options are available.

- [New Dest.]:
Sets the destination to the map location where **<ENTER>** was pushed. If a destination is already set, the location will be set as the new destination.
 “Setting point on map”
(page 4-23)
- [Add to Route]:
Sets the map location where **<ENTER>** was pushed as the destination or a waypoint. This is available only when a suggested route is already set.
 “Setting destination or waypoint”
(page 5-15)
- [Nearby Places]:
Searches for points of interest near the map location where **<ENTER>** was pushed and sets them as a destination or waypoint.
Use the same search method as the one for [Places].
 “Finding nearby place” (page 4-6)
- [Store Location]:
Store the map location where **<ENTER>** was pushed in the Address Book. The stored location can be retrieved to set it as a destination or waypoint.
 “Storing location” (page 6-2)

- [Delete]:
Deletes a stored location. Available only when the cross pointer is placed over a stored location icon.
- [Incident Detail]:
This function can be selected only when the traffic information icon is displayed. Displays the details of the traffic information icon. Place the cross pointer over the icon to be checked.



INFO:

Incident details are a feature of Traffic Information, and a NavTraffic subscription is required in order to receive Traffic Information.

2. Getting started

STORING HOME LOCATION/ADDRESS

HOW TO STORE HOME LOCATION

If a home location is already stored in the Address Book, it can be easily retrieved to set the route to the stored home location.

The procedure to store the home location is the same as for storing any other location.

 “4. Setting destination”

As an example, the procedure for storing the home location by searching for a destination by address is described here.



1. Push **<DEST>**.
2. Highlight [Home (Add New)] and push **<ENTER>**.



3. A confirmation message is displayed. Confirm the message, highlight [Yes] and push **<ENTER>**.

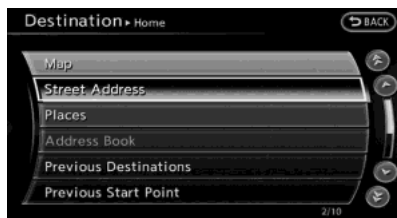

4. Highlight [Street Address] and push **<ENTER>**. A character input screen is displayed.



5. Enter the address of the home location, highlight [OK] and push **<ENTER>**.
 “Finding address” (page 4-4)
The map screen is displayed.

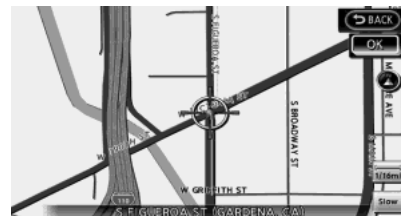

6. Adjust the location of your home using the INFINITI controller, if necessary.
7. After adjusting the location, push **<ENTER>**.

INFO:

It is recommended to move the home location for security reasons.



8. A message is displayed and the home location is stored.



9. Highlight [OK] and push <ENTER>.
10. Push <MAP> to return to the current location map screen. The home icon is displayed on the map.

INFO:

The same setting can also be performed by pushing <SETTING> and highlighting [Navigation].

 "Storing location by searching" (page 6-2)

SETTING DESTINATION

SEARCHING FOR DESTINATIONS

As an example, the method for setting a nearby restaurant as the destination using [Places] is described here.



1. Push <DEST>.
2. Highlight [Places] and push <ENTER>.



3. Highlight [Nearby RESTAURANT] and push <ENTER>.

2. Getting started

INFO:

The search can also be narrowed down by selecting [All Categories or Name] or [ZAGAT] (if so equipped) on this screen. By selecting [All Categories or Name], the area, name of facility, etc. can be specified. By selecting [ZAGAT] (if so equipped), restaurants registered in the ZAGAT database can be searched and sorted by their rating regarding food, decor, cost, service, etc.

The Zagat Content displayed may not reflect the most up-to-date Zagat Content available to the public.



4. Highlight the preferred restaurant from the list and push **<ENTER>**.

INFO:

- The position of the selected location is displayed in the preview on the right side of the screen.

- If there is a route already in progress, only places along the current route will be listed. Turn off [Show Along Route] at the top of list to display all nearby places.

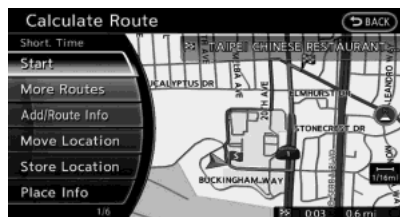

5. The entire route is shown on the map. Highlight [Start] after confirming the location of the displayed destination, and push **<ENTER>**.

The system sets the destination to the selected location and starts calculating a route.

INFO:

Even after setting a destination, the location of the destination can be adjusted and the route can be stored, etc., if necessary.

 "Procedures after setting destination" (page 5-2)

STARTING ROUTE GUIDANCE

After the destination is set and route calculation is performed, the suggested route is displayed.

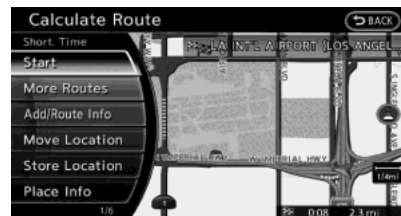

1. Highlight [Start] and push **<ENTER>**.

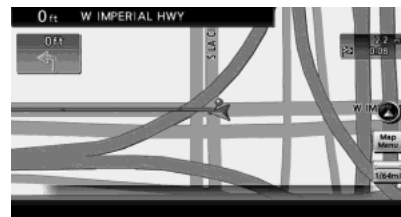

2. Once route guidance is started, the system navigates you through the guide points using visual and voice guidance.

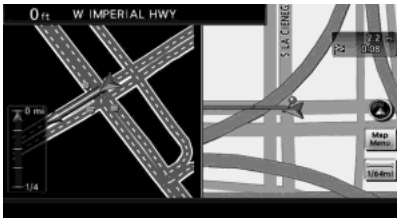

3. When approaching a guide point, the system automatically changes to the split screen and shows an enlarged view of the intersection in the left screen. Push **<MAP>** to switch to the full map screen.



4. When arriving at the destination, route guidance automatically ends.

CANCELING ROUTE

Cancel a route that is already set according to the following procedure.

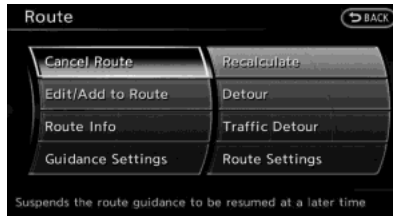

1. Push **<ROUTE>**.
2. Highlight [Cancel Route] and push **<ENTER>**.

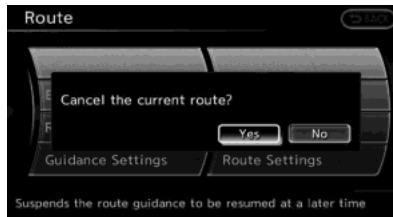

3. A confirmation message is displayed. Highlight [Yes] and push **<ENTER>**.

INFO:

- If a route is canceled, [Cancel Route] changes to [Resume Route]. Highlight [Resume Route] and push **<ENTER>** to reactivate the canceled route. This is available only until a new route is set or a currently set destination is deleted.
- [Cancel Route] does not delete the destination that has been set. To delete a destination, push **<DEST>** and highlight [Next Page] and push **<ENTER>**. And then highlight [Delete Destination] and push **<ENTER>**.
☞ "Delete destination" (page 4-24)

2. Getting started

OPERATING MAPS

HOW TO VIEW MAP SCREEN

The navigation system displays various information on the map screen.

Screen information

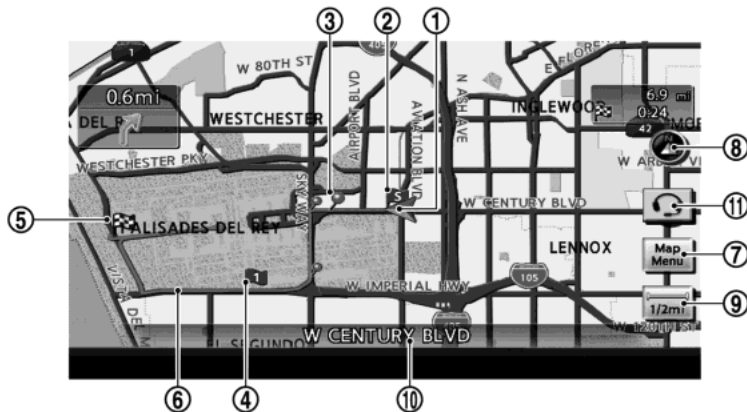

①  Vehicle icon:

Indicates the current vehicle location and the direction of travel.

②  Starting point:

Displays the vehicle location, with which the route is set, as the starting point.

③  Guide point:

Indicates a guide point on the route.

④  Waypoint:

Displays the set locations between the starting point and the destination. A maximum of 5 waypoints can be set.

⑤  Destination:

Indicates the destination location of the route guidance.

Upon reaching the destination, the address will be displayed on the map screen.

⑥ Suggested route:

Appears in bold yellow during route guidance.

⑦  Map Menu icon:

Touch the icon to display the Map Menu screen.

 “Map menu screen” (page 2-18)

⑧  Direction indicator:

Indicates the directional setting of the map. Touch the icon to change the setting.

: North always pointing up.

: Direction of the vehicle always pointing up.

 “Setting map orientation”
(page 3-14)

⑨  Scale indicator:

Indicates the scale of the map.

Touch the icon to display the scale bar. The map scale can be adjusted using the scale bar.

 “Operating with touch panel operation” (page 3-5)

⑩ Street name:

Displays the name of the street that the vehicle is currently driving on.

⑪ IVR soft button (if so equipped):

Touch the icon to connect to the Infiniti Connection™ Interactive Voice Menu.

 “Connecting to Interactive Voice Menu” (page 7-11)



INFO:

Infiniti Connection Interactive Voice Menu is a feature of Infiniti Connection. Use of this feature is dependent upon a valid subscription and the telematics device being in operative condition, as well as cellular connectivity, navigation map data and GPS satellite signal reception being available.

SETTING VOICE GUIDANCE

TURNING VOICE GUIDANCE ON/OFF

Voice guidance can be activated or deactivated.



1. Push **<ROUTE>**.
2. Highlight [Guidance Settings] and push **<ENTER>**.

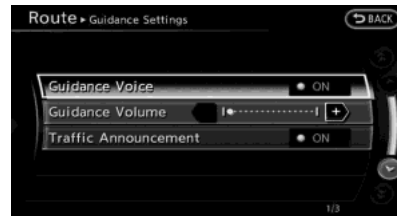

3. Highlight [Guidance Voice] and push **<ENTER>**. The indicator illuminates if voice guidance is activated.

Other settings

Voice guidance can also be activated or deactivated by performing the following procedure.

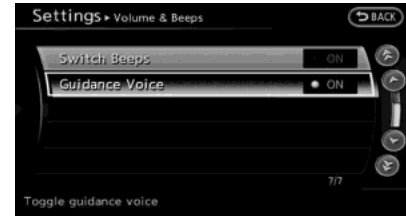

1. Push **<SETTING>**.
2. Highlight [Volume & Beeps] and push **<ENTER>**.
3. Highlight [Guidance Voice] and push **<ENTER>**.

ADJUSTING VOICE GUIDANCE VOLUME

The volume of voice guidance can be adjusted.

2. Getting started



1. Push **<ROUTE>**.
2. Highlight [Guidance Settings] and push **<ENTER>**.

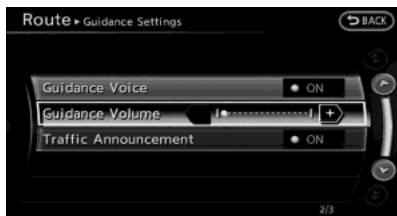

3. Highlight [Guidance Volume] and push **<ENTER>**.

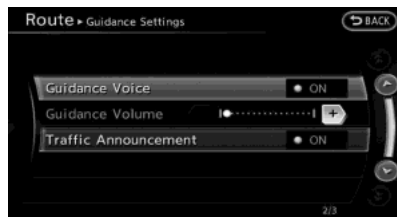

4. Adjust the volume of voice guidance by using the INFINITI controller.

Other settings

The volume of voice guidance can also be adjusted by performing the following procedure.



1. Push **<SETTING>**.
2. Highlight [Volume & Beeps] and push **<ENTER>**.

3. Highlight [Guidance Volume] and push **<ENTER>**.
4. Adjust the volume of voice guidance by using the INFINITI controller.

INFINITI VOICE RECOGNITION

INFINITI Voice Recognition allows hands-free operation of the navigation system and other systems equipped on this vehicle, such as the phone, vehicle information and audio.

INFINITI Voice Recognition can be used in one of two selectable modes, Standard Mode or Alternate Command Mode.

In Standard Mode, the commands that are available are always shown on the display and announced by the system. To perform operations, simply follow the prompts given by the system.

For advanced operations, change to Alternate Command Mode. When this mode is active, an expanded list of commands can be spoken after pushing **◀TALK**  **▶** on the steering wheel, and the voice command menu prompts are turned off. Note that in this mode the recognition success rate may decrease because there are more commands available and more ways of speaking each command. Otherwise, it is recommended that Alternate Command Mode be turned off and Standard Mode be used for the best recognition performance.



INFO:

- For U.S. customers, Standard Mode is selected by default. For Canadian customers, Alternate Command Mode is the default mode.
- For voice recognition system operations related to the phone, audio or vehicle information systems, refer to the vehicle Owner's Manual.
- When the system language is set to "Français" (French) or "Español" (Spanish), the available commands and functions may differ from those that are available when using the system in English.

USING VOICE RECOGNITION SYSTEM

Initialization

When the ignition switch is pushed to the ON position, INFINITI Voice Recognition is initialized, which may take up to one minute. When completed, the system is ready to accept voice commands. If **◀TALK**  **▶** is pushed before the initialization completes, the display will show the message: "System not ready."

BEFORE STARTING

To get the best recognition performance from INFINITI Voice Recognition, observe the following points.

- The interior of the vehicle should be as quiet as possible. Close the windows to eliminate the surrounding noises (traffic noise, vibration sounds, etc.), which may prevent the system from correctly recognizing the voice commands.
- The voice recognition system cannot be operated when the retractable hard top is not closed (for G37 Convertible only).
- Wait until the tone sounds before speaking a command.
- Speak in a natural conversational voice without pausing between words.
- If the air conditioner is set to "AUTO", the fan speed is automatically lowered so that commands can be recognized more easily.

2. Getting started

GIVING VOICE COMMANDS

The method of giving a voice command in Standard Mode is described here.



Type A



Type B

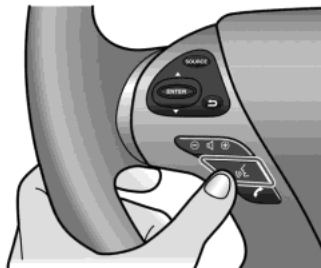



Type C



Type D



Type E

1. Push **TALK**  located on the steering wheel.
2. A list of commands appears on the screen, and the system provides the voice menu prompt.
3. After the tone sounds and the icon on the screen changes from [] to [], speak a command.
4. Continue to follow the voice menu prompts and speak after the tone sounds until the operation is completed.

Operating tips

- Speak a command after the tone.

- Commands that are available are always shown on the display and spoken through voice menu prompts. Commands other than those that are displayed are not accepted. Please follow the prompts given by the system.
- If the command is not recognized, the system announces, “Please say again”. Repeat the command in a clear voice.
- Push <BACK> once to return to the previous screen.
- Push and hold <TALK > to cancel the command. The message, “Voice recognition is canceled” will be announced.

Voice Prompt Interrupt:

Push <TALK > to stop the voice prompt and give the command at once. Remember to wait for the tone before speaking.

VOICE COMMAND EXAMPLES

To use the voice recognition system, speaking one command is sometimes sufficient, but at other times it is necessary to speak two or more commands. As examples, some additional basic operations that can be performed by voice commands are described here.

Example 1: Placing call to phone number 800-662-6200

1. Push <TALK > located on the steering wheel.
2. The system provides the voice menu prompt.
3. Speak “Phone”.



4. Speak “Dial Number”.

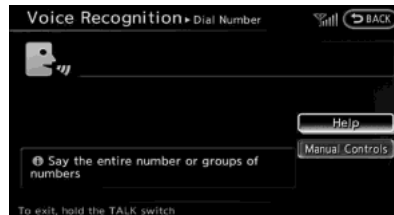

5. Speak “800”.



6. The system announces, “Please say next three digits or dial, or say change number”. Speak “662”.



7. The system announces, “Please say last four digits or say change number”. Speak “6200”.

2. Getting started



8. The system announces, “Dial or Change Number?”. Speak “Dial”.

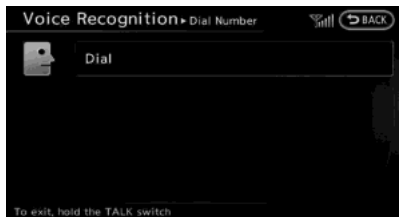

9. The system makes a call to 800-662-6200.

INFO:

- Speaking “800-662-6200” (10 continuous digits) or “662-6200” (7 continuous digits) is acceptable, if the area code is not necessary. However the 3-3-4 digit grouping is recommended for improved recognition.
-  “How to speak numbers” (page 9-14)

- The INFINITI voice recognition system is not limited to recognizing phone numbers of only 7 or 10 digits. To dial a number in a format other than the 3-3-4 digit grouping, use the “International Call” command.
- If “Change Number” is spoken during phone number entry, the system will automatically request that the number be repeated using the 3-3-4 format. In this case, speak the area code first and then follow the prompts.
- Do not add a “1” in front of the area code when speaking phone numbers.
- If the system does not recognize a spoken voice command, try repeating the command using a natural voice. Speaking too slowly or too loudly may further reduce recognition accuracy.

Example 2: Placing international call to phone number 011-81-111-222-333

1. Push **TALK**  located on the steering wheel.
2. The system provides the voice menu prompt.
3. Speak “Phone”.



4. Speak “International Call”.



5. Speak “01181111222333”.



6. Speak “Dial”.



7. The system makes a call to 011-81-111-222-333.



INFO:

Any digit input format is available in the international number input process.

Example 3: Setting destination by street address

1. Push **<TALK**  **>** located on the steering wheel.
2. The system provides the voice menu prompt.
3. Speak “Navigation”.



4. Speak “Address”.



5. Speak the name of the state, “California”.



6. Speak the name of the city, “Gardena”.

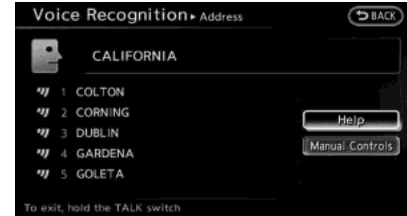

7. Voice feedback will be provided when the command is accepted, and the list of city names is displayed.

8. After the tone sounds and the icon on the screen changes again, speak “Four”.

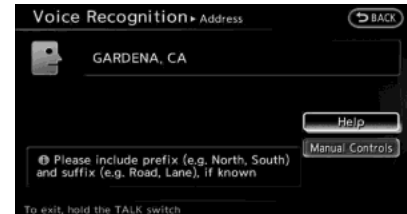

9. Speak the name of the street, “South Figueroa Street”.

2. Getting started

INFO:

Only the official street names stored in the map database can be recognized by the system. To improve accuracy, speak the street name precisely and include boulevard, way, north, south, etc. If the full name is not known, speaking only part of the street name such as “Figueroa” is acceptable, but recognition accuracy may be reduced.

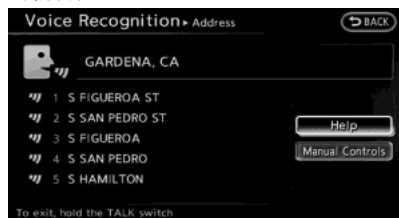

10. Voice feedback will be provided when the command is accepted, and the list of street names appears.

11. After the tone sounds and the icon on the screen changes again, speak “One”.

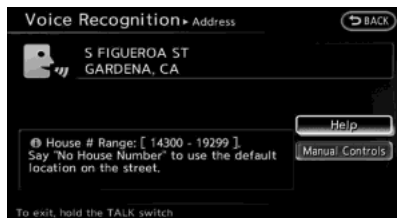

12. Speak the house number.

 “How to speak numbers”
(page 9-14)

INFO:

If the house number is not known, speak “No house number”.

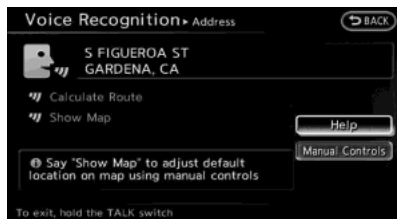

13. To confirm the destination location on the map, speak “Show Map”. To calculate a route, speak “Calculate Route”.

COMMAND LISTS

Category	Command	Action
	Call (Optional)	Makes a call to a contact that is stored in either phonebook. Please say "Call" followed by a stored name.
	Phone	Operates the Phone function.
	Navigation	Operates the Navigation function.
	Information	Displays the Vehicle Information function.
	Audio	Operates the Audio function.
	Help	Displays the User Guide.

Navigation	Command	Action
	Destination Home	Sets a route to the home location that is stored in the Address book.
	Address	Searches for a location by the street address specified, and sets a route (for continental U.S. and Canada only).
	Places	Sets a route to a facility near the current vehicle location.
	Address Book	Searches for information stored in the Address Book.
	Previous Destinations	Sets a route to a previous destination.

2. Getting started

Phone	Command	Action
	Dial Number	Makes a call to a spoken phone number up to 10 digits.
	Quick Dial	Makes a call to a contact that is stored in the Quick Dial.
	Phonebook	Makes a call to a phone number stored in a mobile phone.
Call History	Incoming Calls	Makes a call to an incoming call number.
	Outgoing Calls	Makes a call to a dialed number.
	Missed Calls	Makes a call to a missed calls number.
	International Call	Makes an international call by allowing more than 10 digits to be spoken.

Information	Command	Action
	Fuel Economy	Displays fuel economy information.
	Trip Computer (if so equipped)	Displays trip information.
	Maintenance	Displays maintenance information.
	Where am I?	Displays GPS information.
	Traffic Information	Turns the traffic information system on and off.

Audio	Command	Action
	AM	Turns to the AM band, selecting the station last played.
	FM	Turns to the FM band, selecting the station last played.
	XM	Turns to the SiriusXM Satellite Radio band, selecting the channel last played.
	CD	Starts to play a CD.

General	Command	Action
	Go back	Corrects the last recognition result to return to the previous screen.
	Exit	Cancels Voice Recognition.

**INFO:**

Refer to the vehicle Owner's Manual for the operations related to phone, information and audio.

2. Getting started

MEMO

3 Map settings

Map types	3-2	Changing map view	3-11
2D map	3-2	Other settings	3-12
Birdview™ (3D) map	3-3	Map view settings	3-13
Building graphics	3-3	Basic operation	3-13
Displaying current vehicle location	3-4	Setting map orientation	3-14
Operating with control panel	3-4	Settings long range map view	3-15
Operating with touch panel operation	3-5	Setting map color	3-16
Moving map	3-5	Changing Birdview™ angle	3-16
2D map	3-5	Setting left screen display	3-17
Birdview™ (3D) map	3-7	Looking at information on map	3-18
Changing scale of map	3-8	Displaying map icons	3-18
Operating with ZOOM buttons (if so equipped)	3-8	Map scrolling information	3-19
Operating with center dial	3-9	Map symbols	3-21
Operating with touch panel operation	3-10	Road color	3-22
Map scale	3-10	Traffic information on map	3-22

3. Map settings

MAP TYPES

Two types of map views are available: 2D map and Birdview™ (3D) map.







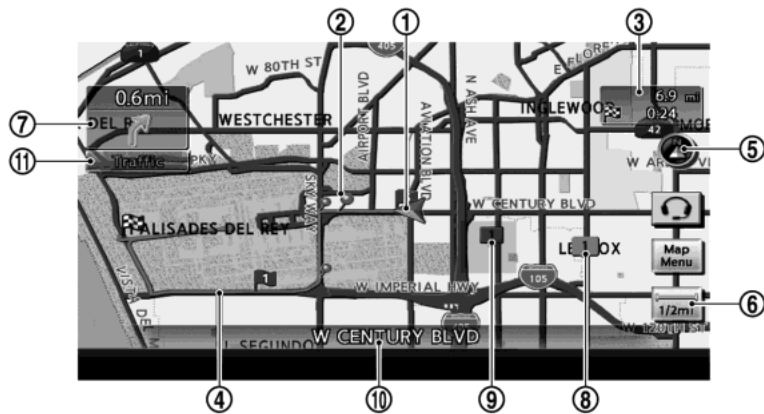

2D MAP

The 2D map displays the map in a 2-dimensional environment similar to a road map.



Screen information



- ① Vehicle icon:
Indicates the current vehicle location and the direction of travel.
- ② Guide point:
Indicates a guide point on the route.
- ③ Remaining time and distance to the destination:
Indicates the approximate remaining time and distance to the destination or waypoint. This indicator will appear when a destination or waypoint is set and route guidance is started.
When the vehicle is not driven on the suggested route, the screen displays the direction to the destination and the distance to the destination from the current vehicle position.
 “Switching estimated arrival time display” (page 5-29)
- ④ Suggested route:
Appears in bold yellow during route guidance.
- ⑤ Direction indicator:
Indicates the directional setting of the map. Touch the icon to change the setting.
: North always pointing up.

- : Direction of the vehicle always pointing up.
 “Setting map orientation” (page 3-14)
- ⑥  Scale indicator:
Indicates the scale of the map. Touch the icon to display the scale bar.
The map scale can be adjusted using the scale bar.
 “Operating with touch panel operation” (page 3-10)
- ⑦  Arrow:
Indicates the distance to the next guide point and the turning direction at that guide point.
- ⑧  Stored location (orange):
Displays the locations that are stored in the Address Book. Icons can be changed according to personal preferences.
 “Storing location” (page 6-2)
- ⑨  Avoid Area (green or blue):
Displays the areas to avoid that are stored in the Address Book with green or blue icons. During the route search, the route guidance is performed by searching for a route that avoids those

areas.

-  “Storing avoid area” (page 6-7)
- ⑩ Street name:
Displays the name of the street the vehicle is currently driving on.
- ⑪  Traffic indicator:
Displays the reception condition of the traffic information transmitted from the provider.
Green: Reception condition is good.
Gray: Reception condition is not good.
No mark: Subscription to NavTraffic service is not detected.

Birdview™ (3D) MAP

Birdview™ displays the map from an elevated perspective. In Birdview™, it is easy to recognize an image of the route because it provides a panoramic view over a long distance.

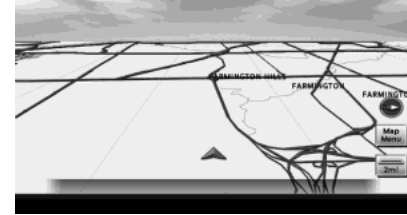

INFO:

Note the following items about the Birdview™ display.

- “Birdview™” is a registered trademark of Clarion Co., Ltd.
- The map in Birdview™ always appears with the current forward direction facing up.

BUILDING GRAPHICS

In an area where the building graphics are stored in the map data, the building graphics are displayed when the map is zoomed in. On the 2D map display, these are called “Building footprint graphics”, and on the Birdview™ display, these are called “3D building graphics”.

The method to look at the map is the same for the 2D and Birdview™ maps.

3. Map settings

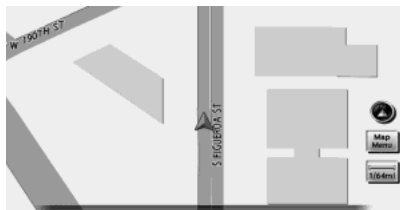

Building footprint graphics (2D map)



3D building graphics (Birdview™ map)

INFO:

In an area where the building graphics are not stored in the map data, the normal map is displayed even when the map is zoomed in.

DISPLAYING CURRENT VEHICLE LOCATION

OPERATING WITH CONTROL PANEL



The basic map screen displays the current location (the position where the vehicle mark is located). Push **<MAP>** to display the current location on the map while on any screen.

OPERATING WITH TOUCH PANEL OPERATION



After moving the map, touch [BACK] on the map screen to display the current location map screen.

MOVING MAP

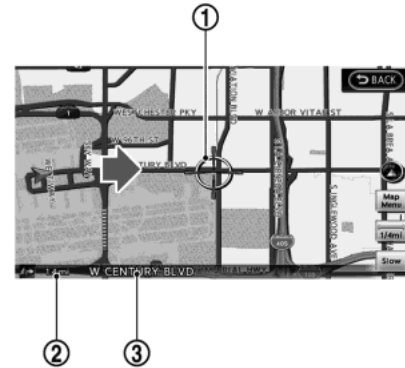

The operations for moving across the map are different between the 2D and Bird-view™ maps.

2D MAP

Screen information:

- ① Cross pointer
- ② Distance from the current location to the cross pointer

- ③ Street name

Operating with INFINITI controller

Push one of the directional buttons or the slide switch. Press and hold a directional button or the slide switch to move continuously across the map in a direction.

While moving across the map, the cross pointer appears.

If the map scale is set to 1/8 mile (200 m) or less, the street indicated by the cross

3. Map settings

pointer will blink in pink and the street name will be displayed.

Operating with touch operation

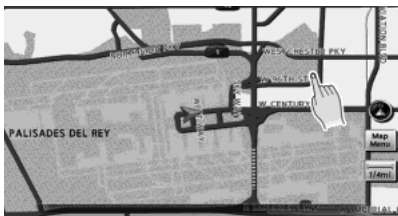

1. Touch the screen.

The cross pointer is displayed, and the touched position is set as the center of the screen.



2. Touch the direction to move to. The map continues to scroll while the screen is touched.

INFO:

While driving, one touch continuous scrolling is disabled. Touch the screen again to scroll further.

If the map screen is set to the building footprint graphics, the map cannot be scrolled while driving.

Fine-tuning the cursor position:



1. Touch [Slow].

The 8-directional key is displayed.

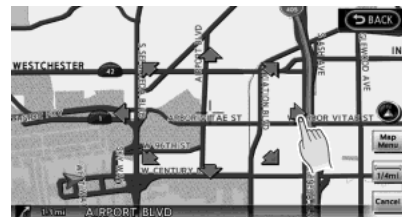

2. Touch the 8-directional key to adjust the cross pointer position. Touch [BACK] to complete the adjustment.

INFO:



Fine-tuning the cursor position is not possible while driving.

Birdview™ (3D) MAP



Screen information:

- ① Cross pointer
- ② Street name
- ③ Distance from the vehicle position to the cross pointer

-  Rotates the map clockwise.
-  Rotates the map counterclockwise.
-  Moves the cross pointer in the direction of the arrow.

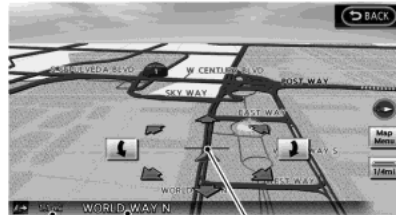

- ③
- ②
- ①

Operating with INFINITI controller

Push one of the directional buttons or the slide switch. Press and hold a directional button or the slide switch to move continuously across the map in a direction.

While moving on the map, the cross pointer appears.

Operating with touch panel

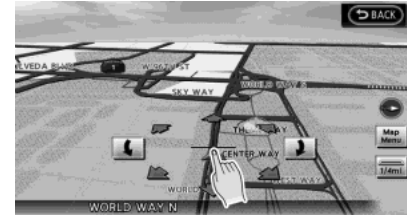

1. Touch the screen.

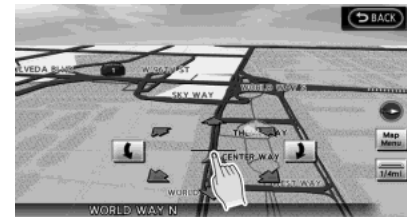

The cross pointer and 8-directional key are displayed.

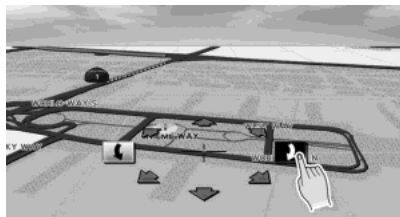

2. Touch the direction to move to. The map continues to scroll while the screen is touched.

3. Map settings



3. Touch  or  to change the direction of the map.



: Rotates the map clockwise.



: Rotates the map counterclockwise.



INFO:

While driving, one touch continuous scrolling is disabled. Touch the screen again to scroll further.

CHANGING SCALE OF MAP

OPERATING WITH ZOOM BUTTONS (if so equipped)

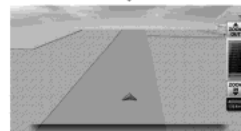
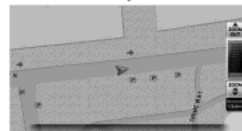
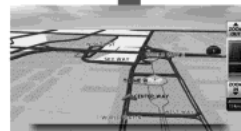

Push **<ZOOM IN>** or **<ZOOM OUT>**. A scale appears on the right side of the screen.

To view the map in detail, push **<ZOOM IN>**.

To view a wider area, push **<ZOOM OUT>**.

The scale will automatically disappear when neither **<ZOOM IN>** nor **<ZOOM OUT>** has been pushed for several seconds.

If the scaling operation is not performed for a specified period of time, the scale display disappears.

INFO:

Free zoom:

The scale can be changed in smaller steps when **<ZOOM IN>** or **<ZOOM OUT>** is pushed and held than when the button is pushed briefly. When the button is pushed briefly, the scale can be changed in large steps.

 "Other navigation settings" (page 8-7)

OPERATING WITH CENTER DIAL

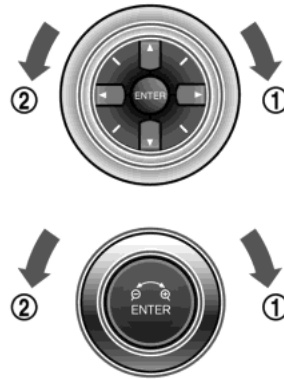

1. Turn the center dial when the map screen is displayed. The map scale is displayed at the right side of the screen.
2. Use the center dial to adjust the map scale.
 - ① Clockwise: Zoom in
 - ② Counterclockwise: Zoom out



INFO:

Free zoom:

Depending on the setting, using the center dial to change the map scale may adjust the scale normally, or it may engage the free zoom (finer scale adjustment in smaller steps).

 "Other navigation settings" (page 8-7)

3. Map settings

OPERATING WITH TOUCH PANEL OPERATION

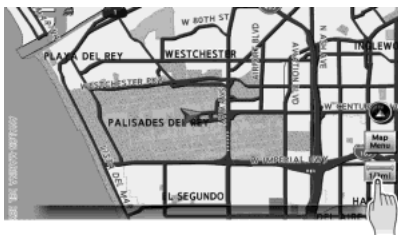

1. Touch [].
The scale is displayed.



2. Touch [ZOOM IN] or [ZOOM OUT] to change the scale.

INFO:

Free zoom:

Once the [Small Step Zoom by Dial] is set to ON in the setting screen, the scale can be changed in smaller steps when [ZOOM IN] or [ZOOM OUT] is pushed and held than when either button is briefly pushed. If briefly pushed, the operation returns to normal.

Voice command

1. Push <TALK  > located on the steering wheel.
2. After the tone sounds, speak a command.

To change the map scale:

“Zoom In <1 to 13>” (Alternate Command Mode)

“Zoom Out <1 to 13>” (Alternate Command Mode)

MAP SCALE

Any required map scale (map coverage) between 320 miles (640 km) and 1/64 of a mile (25 m) can be selected.

Scale level for 2D map and Bird-view™ map (3D) display

	US Units	Metric Units
Normal Map	320 miles	640 km
	80 miles	160 km
	32 miles	64 km
	8 miles	16 km
	5 miles	10 km
	2 miles	4 km
	1 mile	2 km
	1/2 mile	1 km
	1/4 mile	500 m
	1/8 mile	200 m
Shows building footprint graphics	1/16 mile	100 m
	1/32 mile	50 m
	1/64 mile	25 m

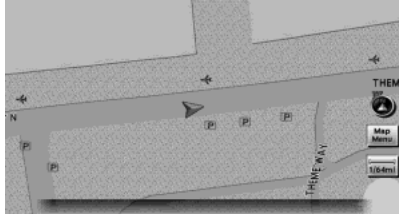

Example: The most detailed level (2D map)



Example: The widest level (2D map)

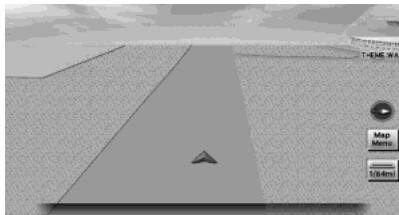

Example: The most detailed level (Birdview™ map)

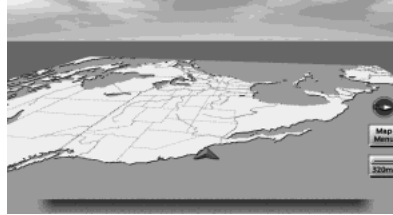

Example: The widest level (Birdview™ map)

INFO:

The traffic information icons are not displayed on the map screen when the map scale is set to 32 miles (64 km) or higher.

 “Traffic information display and scale levels” (page 7-20)

CHANGING MAP VIEW

The map view can be changed between the 2D and Birdview™ maps. The map can also be displayed in the split screen mode.



1. Push **<ENTER>** while the current location map screen is displayed.

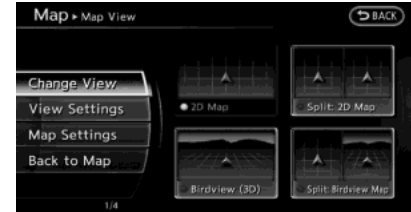

2. Highlight [Map View] and push **<ENTER>**.

3. Map settings

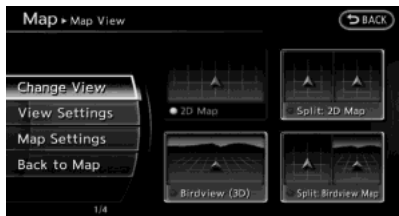

1. Highlight [Change View] and push the right button of the directional buttons or push the slide switch to the right.
2. Highlight the preferred map view and push **<ENTER>**. The indicator of the selected map view illuminates.
3. The display automatically returns to the map screen.

Available views

- [2D Map]:
Switches to the 2D map.
- [Birdview (3D)]:
Switches to the Birdview™ map.
- [Split: 2D Map]:
Changes to the split screen mode and both halves display maps in 2D.
- [Split: Birdview Map]:
Changes to the split screen mode and

the left half displays the map in 2D and the right half displays the map in Birdview™.



INFO:

- When the split screen mode is selected, the map settings for the left screen can be changed independently.
 ☞ “Setting left screen display” (page 3-17)
- If the split screen mode is selected, the normal map scrolling and scale adjustment are set in the right screen.
- The map direction or scale for each screen can be adjusted independently by touching an icon on the map.

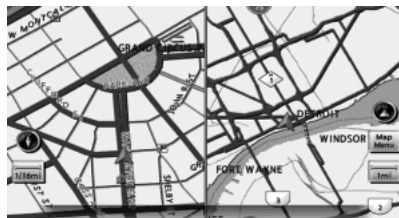

Split: 2D Map

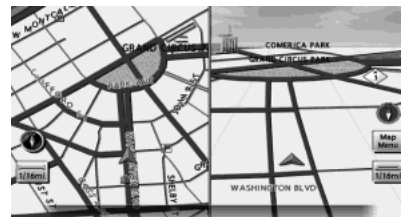

Split: Birdview™ Map

OTHER SETTINGS

The map view can also be set by performing the following procedure.

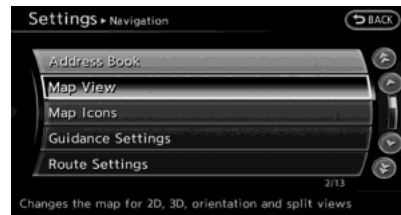

1. Push **<SETTING>**.
2. Highlight [Navigation] and push **<ENTER>**.
3. Highlight [Map View] and push **<ENTER>**.
4. Highlight [Change View] and push **<ENTER>**.

5. Highlight the preferred item and push **<ENTER>**.



Voice command

1. Push **<TALK >** located on the steering wheel.
2. After the tone sounds, speak a command.
 - To display the 2D map: “Plan View map” (Alternate Command Mode)
 - To display the Birdview™ map: “Birdview map” (Alternate Command Mode)

MAP VIEW SETTINGS

Other settings are also available for the map screen, such as changing the map direction, map color, Birdview™ angle, etc.

BASIC OPERATION



1. Push **<ENTER>** while the current location map screen is displayed.



2. Highlight [Map View] and push **<ENTER>**.

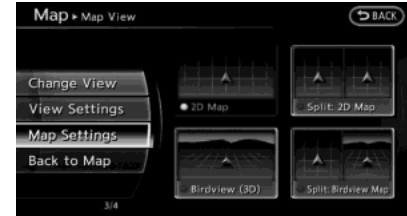

3. Highlight [Map Settings] and push **<ENTER>**.



4. Highlight the preferred item and push **<ENTER>**.

Available setting items

- [Map Orientation]: Sets the map direction to North Up or Heading Up.
 “Setting map orientation” (page 3-14)

3. Map settings

- [Long Range]:
Sets the long range map view display on/off.
☞ “Settings long range map view” (page 3-15)
- [Map Color]:
Changes the map color.
☞ “Setting map color” (page 3-16)
- [Birdview Angle]:
Changes the Birdview™ angle.
☞ “Changing Birdview™ angle” (page 3-16)
- [Left Split Map Settings]:
Sets the map settings for the left screen of the split map.
☞ “Setting left screen display” (page 3-17)
- [Show all Freeway Exits on Route]/
[Auto. Show Turn List on Freeway]:
Sets the display of the freeway exit information on/off.
☞ “Show exit information on freeways” (page 5-11)

Other settings

The orientation of the map can also be set by performing the following procedure.

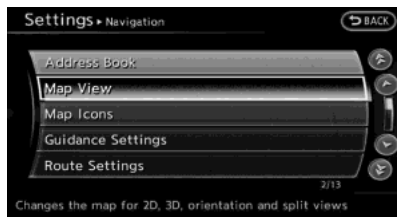

1. Push **<SETTING>**.
2. Highlight [Navigation] and push **<ENTER>**.
3. Highlight [Map View] and push **<ENTER>**.

SETTING MAP ORIENTATION

The map direction (orientation) can also be changed in the 2D map. These settings are available only in the 2D map or 2D/2D split map.



1. Highlight [Map Orientation] and push **<ENTER>**.

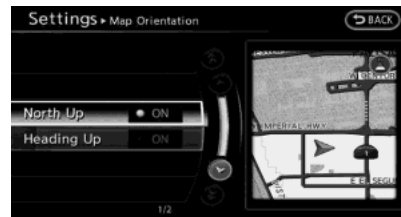

2. Highlight the preferred map orientation and push **<ENTER>**. The indicator of the selected map orientation illuminates.
3. Push **<MAP>** to return to the current location map screen.

3. Map settings

Available map orientations

- [North Up]:
The top of the map remains oriented to the north, and the vehicle icon rotates on the map.
- [Heading Up]:
The vehicle icon always points up on the screen and the map rotates.



INFO:

If the map orientation is switched, the direction indicator icon displayed in the lower left corner is also switched.

- : North Up
- : Heading Up

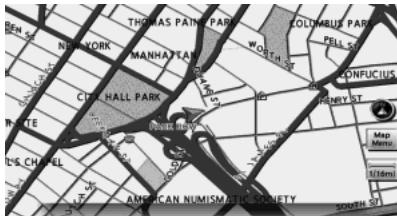

North Up

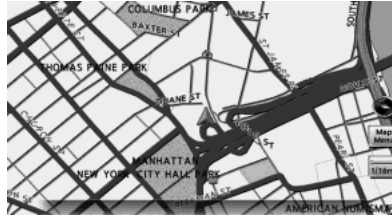

Heading Up



INFO:

The direction of the map can also be changed by touching the direction icon on the map screen.



Voice command

1. Push <TALK > located on the steering wheel.
2. After the tone sounds, speak a command.

To change the map direction:

- “North Up” (Alternate Command Mode)
- “Heading Up” (Alternate Command Mode)

SETTINGS LONG RANGE MAP VIEW

The position of the vehicle icon can be changed to view a wider area in the traveling direction. If this function is activated, the vehicle icon is located slightly lower than the center of the screen.

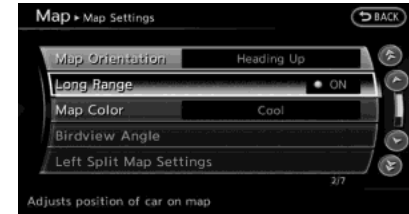

1. Highlight [Long Range] and push <ENTER>. The indicator illuminates.
2. Push <MAP> to return to the current location map screen.

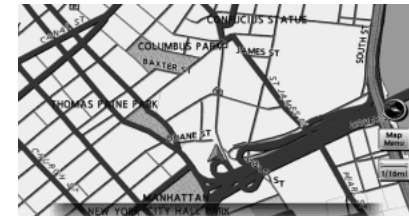

Long Range Map View

3. Map settings

INFO:

[Long Range] is displayed only when [Heading Up] is selected.

SETTING MAP COLOR

The map color can be changed to a warm or cool color, or a light color, to emphasize the traffic information.



1. Highlight [Map Color] and push **<ENTER>**.

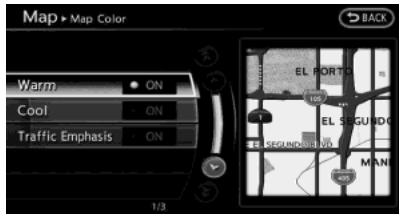

2. Highlight the preferred map color and push **<ENTER>**. The indicator light of the selected color illuminates.

Available map colors

The following map colors are available.

- [Warm]:
Sets warm colors for the map coloring.
- [Cool]:
Sets cool colors for the map coloring.
- [Traffic Emphasis]:
Sets light colors for the map coloring to emphasize the traffic information.

INFO:

The effect of the setting changes can be confirmed on the preview displayed on the right side of the screen.

CHANGING Birdview™ ANGLE

The Birdview™ angle can be changed.

This setting is available only in the Birdview™ map or 2D/Birdview™ split map.

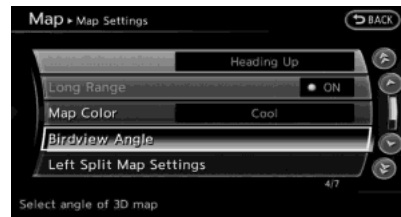

1. Highlight [Birdview Angle] and push **<ENTER>**.

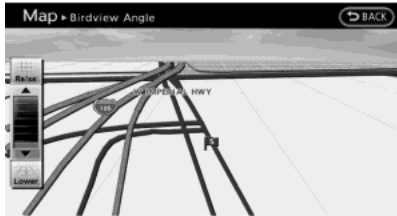
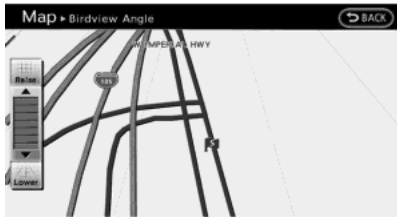

2. Adjust the Birdview™ angle using the INFINITI controller.
3. Push **<MAP>** to return to the current location map screen.

SETTING LEFT SCREEN DISPLAY

When the split screen is displayed, the map settings of the left screen can be changed.

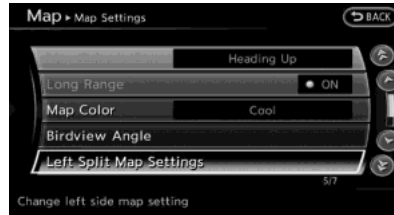

1. Highlight [Left Split Map Settings] and push **<ENTER>**.

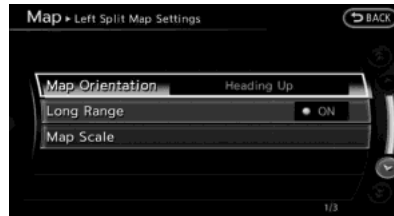

2. Highlight the preferred map setting and push **<ENTER>**.
3. Push **<MAP>** to return to the current location map screen.

Available setting items

- [Map Orientation]:
The map direction can be selected as follows.
 - [North Up]:
The top of the map remains oriented to the north, and the vehicle icon rotates on the map.
 - [Heading Up]:
The vehicle icon always points up on the screen and the map rotates.
- [Long Range]:
Positions the vehicle icon slightly lower than the center of the screen. This offers a wider view in the traveling direction.
- [Map Scale]:
Displays a scale on the left side of the screen. Use this to change the scale of a map.



INFO:

- The settings of the right screen are the same as the settings of the full screen map.
- The map settings can also be changed by touching the direction indicator or the scale

3. Map settings

indicator icon on the map.

LOOKING AT INFORMATION ON MAP

Icons can be displayed on the map, and information about destinations and landmarks can be displayed.

DISPLAYING MAP ICONS

The map icons can be displayed or hidden by type.



1. Push **<ENTER>** while the current location map screen is displayed.



2. Highlight [Map Icons] and push **<ENTER>**.

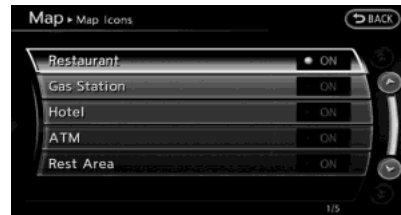

3. Highlight the preferred icon and push **<ENTER>**. The icon display setting toggles between on and off each time **<ENTER>** is pushed. The indicator of the selected icon illuminates.

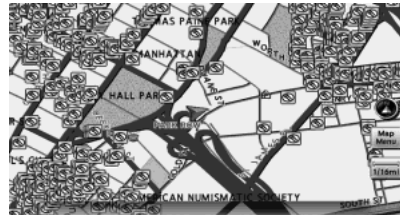





4. Push **<MAP>** to return to the current location map screen. The activated icons are displayed on the map.

INFO:

If they are registered in the map data, the brand icons will be displayed on the map instead of the general map icons listed below.

Map icons that can be displayed

The following map items can be displayed.

-  Restaurant
-  Gas Station
-  Hotel
-  ATM
-  Rest Area

Other settings

The map icons can also be set by performing the following procedure.

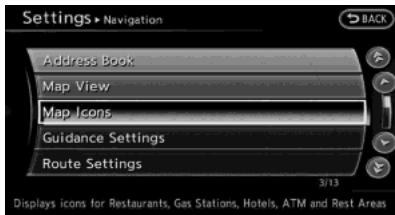

1. Push **<SETTING>**.

2. Highlight [Navigation] and push **<ENTER>**.

3. Highlight [Map Icons] and push **<ENTER>**.

INFO:

- The map icons are not displayed on the map screen when the map scale is set to 1/4 mile (500 m) or higher in the 2D map, or to 1 mile (2 km) or higher in the Birdview™ map.

- When the [Small Step Zoom by Dial] is set to ON; In 2D map, even when the map scale icon indicates 1/8 mile (200 m), the map icons are not displayed unless the map is set to the most zoomed in step within the scale level.

In Birdview™ map, even when the map scale icon indicates 1/2 mile (1 km), the map icons are not displayed unless the map is set to the most zoomed in step within the scale level.

MAP SCROLLING INFORMATION

Information about the location, on which the center of the cross pointer is placed by scrolling on the map, can be set to be displayed.

1. Push **<SETTING>**.

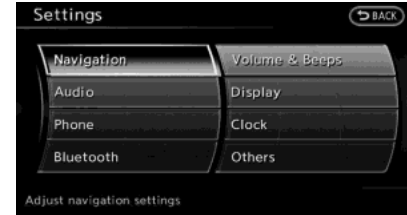

2. Highlight [Navigation] and push **<ENTER>**.



3. Highlight [Others] and push **<ENTER>**.

3. Map settings

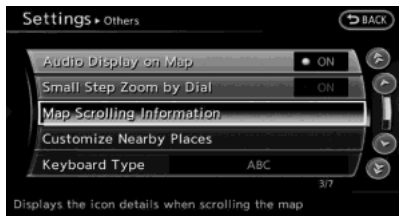

4. Highlight [Map Scrolling Information] and push **<ENTER>**.

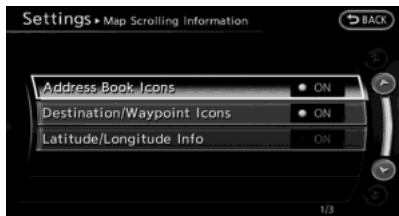

5. Highlight the preferred information item and push **<ENTER>**. The indicator of the selected information item illuminates.

The following information items are available.

- [Address Book Icons]
- [Destination/Waypoint Icons]

- [Latitude/Longitude Info]





























6. Push **<MAP>** to return to the current location map screen. Move the cross pointer to the set location to display the information.

MAP SYMBOLS

This navigation system uses symbols to display facilities.

2D MAP (Plan View)

 Airport	 Golf Course	 Museum	 Shopping Center
 Amusement Park	 Gas Station	 Open Parking Area	 Sports Complex
 Bank	 Historical Monument	 Park & Ride	 Station
 City Hall	 Hotel or Motel	 Parking Garage	 Super Market
 Commuter Rail Station	 Library	 Police Station	 Tourist Office
 Courthouse	 Marina	 Rest Area	 University or College
 Ferry Terminal	 Military Base	 Restaurant	

3. Map settings

ROAD COLOR

The road types are differentiated by colors.

Freeway:

— (Red or light red (zoomed in))

Main road:

— (Brown or dark yellow)

Narrow street:

— (Gray)

Road with incomplete map data:

— (Dark green)

TRAFFIC INFORMATION ON MAP

With a subscription to the NavTraffic service, traffic information is displayed.

 "Viewing available traffic information" (page 7-16)

Free Flow:

→ (Green)

Moderate traffic:

→ (Yellow)

Heavy traffic:

→ (Red)

Section affected by serious traffic event:

→ (Purple)

The following traffic information icons may

be displayed

: Accident

: Closed road

: Information

: Road work

: Slippery road

: Weather

: Incident

4 Setting destination

Destination screen	4-2	Setting previous start point	4-16
Basic operation.....	4-2	Setting from stored routes.....	4-17
Changing region.....	4-3	Setting by phone number	4-18
Finding address	4-4	Setting freeway entrance/exit.....	4-19
Finding place	4-6	Setting intersection	4-20
Setting home as destination	4-11	Setting city center	4-22
Searching from address book.....	4-12	Setting point on map.....	4-23
Setting previous destination	4-13	Delete destination	4-24
Setting by Infiniti Connection™ (if so equipped).....	4-14		

4. Setting destination

DESTINATION SCREEN

There are several methods that can be used to set a destination. Understand the advantages of each method and select the best method for finding and setting a preferred destination.



BASIC OPERATION

1. Push **<DEST>**.
2. Highlight the preferred destination setting method and push **<ENTER>**.

Available setting items

- [Street Address] : Searches for a destination by address.
- [Places] : Searches for a destination from various categories of business or locations, or searches from the facilities in ZAGAT (if so equipped).

- [Home] : Searches for a route from the current location to the previously stored home destination.
- [Address Book] : Searches for a destination from the list of the stored locations.
- [Previous Destination] : Searches for a destination from the previous destinations.
- [Connected Search] (if so equipped) : Searches for a destination by connecting to the Infiniti Connection™ Data Center.

Available setting items (next page screen)

- [Delete Destination] : Deletes the currently set destination.
- [Previous Start Point] : Sets the previous starting point as the destination.
- [Stored Routes] : Selects a stored route.
- [Phone Number] : Searches for a point of interest by a telephone number.

- [Freeway Entrance/Exit] : Searches for a destination from a freeway entrance/exit.
- [Intersection] : Searches for a destination from intersections.
- [City Center] : Sets the center of a city as the destination.

INFO:

- [Connected Search] is a feature of Infiniti Connection. Use of this feature is dependent upon a valid subscription and the telematics device being in operative condition, as well as cellular connectivity, navigation map data and GPS satellite signal reception being available.
- [Phone Number] cannot be used to search for a location with a residential phone number.

CHANGING REGION

When setting a destination, the correct region must be selected.

To narrow down the location, the city can also be specified.

Specifying region



1. Push **<DEST>**.
2. Highlight [Change Region] and push **<ENTER>**.



3. Highlight the preferred region and push **<ENTER>**.

Available setting items

- US1: CA, NV
- US2: AZ, CO, ID, MT, NM, OR, UT, WA, WY
- US3: IA, KS, MN, MO, ND, NE, SD
- US4: AR, LA, MS, OK, TX
- US5: IL, IN, MI, WI
- US6: DC, DE, KY, MD, OH, PA, VA, WV
- US7: CT, MA, ME, NH, NJ, NY, RI, VT
- US8: AL, FL, GA, NC, SC, TN
- US9: AK
- US10: HI
- Canada
- Puerto Rico
- Virgin Islands



INFO:

- It is also possible to select a region by touching the map on the right side of the screen.

- It is not possible to search for a route from the continental United States to Hawaii, Puerto Rico and Virgin Islands.

Specifying city

When searching for a destination with “Places”, “Freeway Entrance/Exit”, “Intersection” or “City Center”, the search can be narrowed down by specifying the city.

For “City Center”, you can only change the region.

As an example, the procedure for specifying the city from “Places” is described here.

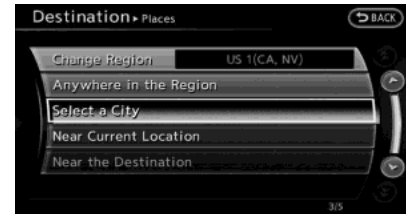

1. Highlight [Select a City] and push **<ENTER>**.

4. Setting destination



2. Enter the name of the city, highlight [List] and push **<ENTER>**.

A list screen is displayed.

INFO:

- The same screen will be displayed when a location is searched by “Street Address”, “Freeway Entrance/Exit” or “Intersection”, and when [City] is highlighted and **<ENTER>** is pushed.
 “Finding address” (page 4-4)
- Highlight [Last 5 Cities] and push **<ENTER>** to display the last 5 cities recently set as destinations.



3. Highlight the city of the destination from the list and push **<ENTER>**.

INFO:

There are instances when the destination list screen number will be less than what was shown in the matches screen, but this is due to the system automatically determining that some destinations are duplicates. The “Matches” destinations includes duplicates. When the [LIST] is highlighted and **<ENTER>** is pushed, the system does a further analysis to remove the duplicates, so the number is sometimes less.

FINDING ADDRESS

When the address of the destination is known, use the following method to enter the address and then have the system calculate a route. A location near the preferred destination can also be searched by entering the house number if the map data contains the relevant data.



1. Push **<DEST>**, highlight [Street Address] and push **<ENTER>**. A character input screen is displayed.



4. Setting destination

2. Enter the house number, highlight [OK] and push **<ENTER>**. If the house number is not available, highlight [No House #] and push **<ENTER>**. A street name input screen is displayed.



3. Enter the name of the street. After finishing the entry, highlight [List] and push **<ENTER>**. A list of streets is displayed.



INFO:

When [City] is highlighted and **<ENTER>** is pushed, a city can be specified by typing the city name.

“Specifying city” (page 4-3)



4. Highlight the correct street of the destination from the list and push **<ENTER>**.



INFO:

In some cases, when a street name has been entered, the number of matching destinations in the “Matches” column may be different from the number displayed on the list screen. If this occurs, enter more characters to further reduce the number of matches.



5. The entire route is shown on the map. Highlight [Start] after confirming the location of the displayed destination, and push **<ENTER>**. The system sets the destination to the selected location and starts calculating a route.



INFO:

Even after setting a destination, the location of the destination can be adjusted, the route can be stored, etc.

“Procedures after setting destination” (page 5-2)



Voice command

1. Push **<TALK>** located on the steering wheel.
2. After the tone sounds, speak a command.

To set the destination from a street address:

“Navigation” “Address” (Standard Mode)

“Address” (Alternate Command Mode)

4. Setting destination

INFO:

When using a voice command to set a street name, it is recommended that the complete street name is stated.

Examples:

Correct input – North Elm Street
East Jefferson Boulevard

Incorrect input – Elm Street
East Jefferson

FINDING PLACE

There are several methods for setting a place of interest as the destination. These include typing a name, choosing a category or selecting a ZAGAT reviewed location (if so equipped). To help improve searching, different start points can be chosen to search from such as near current location, near the destination or city center.

Finding nearby place



1. Push **<DEST>**.
2. Highlight [Places] and push **<ENTER>**.



3. Highlight the preferred nearby category from the list and push **<ENTER>**.

A list screen is displayed.

INFO:

Highlight [Customize Nearby Places] to customize the 5 nearby categories to show

the categories that you frequently use.

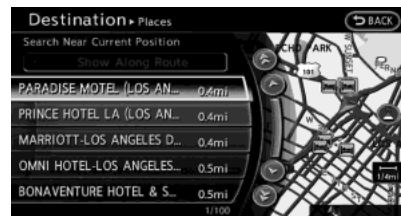

4. Highlight the preferred destination from the list, and push **<ENTER>**. The position of the selected location is displayed in the preview on the right side of the screen.

INFO:

- A maximum of 100 facilities can be displayed on the list screen.
- To search for facilities along your route, select [Show Along Route].



- The entire route is shown on the map. Highlight [Start] after confirming the location of the displayed destination, and push **<ENTER>**. The system sets the destination to the selected location and starts calculating a route.



INFO:

- If there is a route already set, the newly selected location can substitute a previously set destination or can be added to a route already set.
- To review the destination location again, highlight [Move Location] and push **<ENTER>**.

Other settings:



The destination can also be set by pushing **<ENTER>** in the current or scrolled location map screen and selecting [Nearby Places].



Voice command

- Push **<TALK>** located on the steering wheel.
- After the tone sounds, speak a command.

To display the nearby category list and select the destination from it:
 “Navigation” “Places” (Standard Mode)
 “Places” (Alternate Command Mode)

Searching by other methods



- Push **<DEST>**.
- Highlight [Places] and push **<ENTER>**.



- Highlight [All Categories or Name] and push **<ENTER>**.

4. Setting destination



4. Set the narrowing down conditions for the landmarks and push **<ENTER>**.

INFO:

Highlight [Change Region] and push **<ENTER>** to change the region. A screen for selecting a region is displayed.

 "Changing region" (page 4-3)



INFO:

If [Select a City] is highlighted and **<ENTER>** is pushed, a city name input screen is displayed. Specify the city to be searched before narrowing down the categories.

 "Specifying city" (page 4-3)



5. Highlight the main category from the list and push **<ENTER>**.



INFO:

To select a category by directly inputting the category name, highlight [Category Search] and push **<ENTER>**. The category name input screen is displayed.



6. Highlight the subcategory and push **<ENTER>**.

INFO:

Subcategories may not exist depending on the category that is selected.



4. Setting destination

7. Enter the name of the destination facility and highlight [List], and then push **<ENTER>**.

The facility list is displayed.

INFO:

- It is not necessary to enter the facility name completely. It is also possible to display the list screen only by highlighting [List] without entering the facility name and pushing **<ENTER>**.
- The number of narrowed down points are displayed in the “Matches” column.
- Up to two keywords (part of the facility name) can be entered by highlighting [AND Search] and pushing **<ENTER>** after entering the first facility name.



INFO:

The facility name can also be entered directly by highlighting [Choose Name] on the main category list screen and pushing **<ENTER>**



8. Highlight the preferred destination from the list, and push **<ENTER>**.

INFO:

- By highlighting [Sort] and pushing **<ENTER>**, options can be sorted from [By Name] or [By Dist.]. When selecting [By Dist.], the position of the selected location is displayed in the preview on the right side of the screen.
- In some cases, when a facility name has been entered, the number of matching destinations in the “Matches” column may be different from the number

displayed on the list screen. If this occurs, enter more characters to further reduce the number of matches.

- The search conditions can be changed by highlighting [Refine] and pushing **<ENTER>**.



9. The entire route is shown on the map. Highlight [Start] after confirming the location of the displayed destination and push **<ENTER>**. The system sets the destination to the selected location and starts calculating a route.

INFO:

Even after setting a destination, the location of the destination can be adjusted, the route can be stored, etc.

 “Procedures after setting destination” (page 5-2)

4. Setting destination

Searching for restaurant using ZAGAT (if so equipped)



1. Push **<DEST>**.
2. Highlight [Places] and push **<ENTER>**.



3. Highlight [ZAGAT] and push **<ENTER>**.

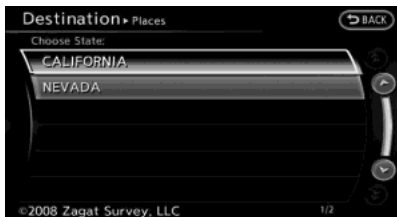

4. Highlight the preferred state and push **<ENTER>**. A list screen is displayed.



5. Highlight the preferred city and push **<ENTER>**. A list screen is displayed.



6. Highlight [RESTAURANT] and push **<ENTER>**. A list screen is displayed.



7. Highlight the preferred category and push **<ENTER>**. A list screen is displayed.



8. Highlight the preferred sorting order and push **<ENTER>**. A list screen is displayed.

4. Setting destination



9. Highlight the preferred destination facility from the list, and then push **<ENTER>**.

INFO:

- By highlighting [Sort] and pushing **<ENTER>**, sorting options can be selected to re-sort the list.
- The search conditions can be changed by highlighting [Refine].
- By highlighting [Ratings] and pushing **<ENTER>**, an explanation of the ZAGAT ratings can be displayed.



10. The entire route is shown on the map. Highlight [Start] after confirming the location of the displayed destination and pushing **<ENTER>**. The system sets the destination to the selected location and starts calculating a route.

INFO:

Even after setting a destination, the location of the destination can be adjusted, the route can be stored, etc.

 “Procedures after setting destination” (page 5-2)

©2009 Zagat Survey, LLC. Zagat Survey is a registered trademark of Zagat Survey, LLC.

SETTING HOME AS DESTINATION

The home location can be set as the destination to which the system calculates a route. This function is especially useful when searching for a route to return to the home location.



1. Push **<DEST>**.
2. Highlight [Home] and push **<ENTER>**.

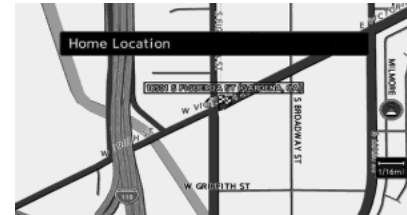

3. The home location is displayed, and the system sets the home location as the destination.

4. Setting destination

INFO:

If the home location is not stored yet, the system will automatically display a screen for storing it.

 “Storing location” (page 6-2)



4. The entire route to the home location is shown on the map. Highlight [Start] after confirming the location of the displayed destination, and push **<ENTER>**. The system sets the destination to the selected location and starts calculating a route.

Voice command

1. Push **<TALK>**  located on the steering wheel.
2. After the tone sounds, speak a command.

To set the home location as the

destination:

“Navigation” “Destination Home” (Standard Mode)

“Destination Home” (Alternate Command Mode)

SEARCHING FROM ADDRESS BOOK

Storing frequently used destinations in the Address Book makes it easy for the system to set and calculate a route. To utilize this function more effectively, destinations that are often traveled to should be stored in advance.



1. Push **<DEST>**.
2. Highlight [Address Book] and push **<ENTER>**. A list screen is displayed.



3. Highlight the preferred location from the list and push **<ENTER>**.

INFO:

Selecting [Sort] displays a list of various sort functions. To use the sort functions, stored locations must be set in advance.

 “Storing location” (page 6-2)

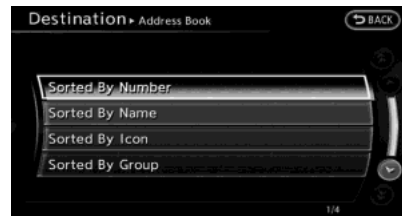

INFO:

- **Sorted By Number:**
The Address Book entries are displayed in ascending numerical order.
- **Sorted By Name:**
The Address Book entries are displayed in alphabetic order.
- **Sorted By Icon:**
By selecting a particular icon, a list that contains only the Address Book entries associated with that icon is displayed.
- **Sorted By Group:**
By selecting a particular group (family, friends, leisure, etc.), the selected group is displayed at the top of the list.



4. The entire route is shown on the map. Highlight [Start] after confirming the location of the displayed destination, and push **<ENTER>**. The system sets the

destination to the selected location and starts calculating a route.

INFO:

Even after setting a destination, the location of the destination can be adjusted, the route can be stored, etc.

 “Procedures after setting destination” (page 5-2)

Voice command

1. Push **<TALK>**  located on the steering wheel.
2. After the tone sounds, speak a command.

To set the destination from the Address Book:

“Navigation” “Address Book” (Standard Mode)

“Address book” (Alternate Command Mode)

SETTING PREVIOUS DESTINATION

It is possible to set the destination to a location that has been previously set as a destination and have the system calculate a route. Up to 300 previous destinations will be automatically stored.

If the number of previous destinations exceeds 300, the oldest one will be replaced by the newest one.

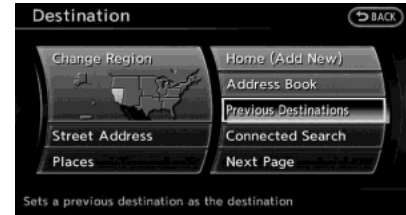

1. Push **<DEST>**.
2. Highlight [Previous Destinations] and push **<ENTER>**. A list screen is displayed.

4. Setting destination



3. Highlight the preferred destination from the list and push **<ENTER>**.

INFO:

The list can be sorted by selecting [By Date] or [By Name]. Highlight [By Date] to sort the list in chronological order. Highlight [By Name] to sort the list in alphabetical order.



4. The entire route is shown on the map. Highlight [Start] after confirming the location of the displayed destination, and push **<ENTER>**. The system sets the

destination to the selected location and starts calculating a route.

INFO:

Even after setting a destination, the location of the destination can be adjusted, the route can be stored, etc.

 “Procedures after setting destination” (page 5-2)

Voice command

1. Push **<TALK < >** located on the steering wheel.
2. After the tone sounds, speak a command.

To display the previous destinations list:

“Navigation” “Previous Destinations” (Standard Mode)

“Previous Destinations” (Alternate Command Mode)

SETTING BY INFINITI CONNECTION™ (if so equipped)

It is possible to set the destination using the Infiniti Connection features.

 “Infiniti Connection™” (page 7-3)

INFO:

Use of Infiniti Connection features is dependent upon a valid subscription and the telematics device being in operative condition, as well as cellular connectivity, navigation map data and GPS satellite signal reception being available.

Searching by connecting Data Center

You can find your point of interest by inputting a keyword and connecting to the Infiniti Connection Data Center. The searched location can be set as a destination.

1. Push **<DEST>**.

4. Setting destination



2. Highlight [Connected Search] and push **<ENTER>**.



3. Enter the keyword, highlight [Search] and push **<ENTER>**. The system will connect to the Infiniti Connection Data Center and the search results will be displayed.



INFO:

The search history can also be reused by highlighting [History] and pushing **<ENTER>**.



4. Highlight the preferred destination from the list and push **<ENTER>**.

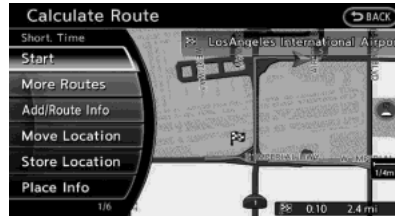

5. The entire route is shown on the map. Highlight [Start] after confirming the location of the displayed destination, and push **<ENTER>**. The system sets the destination to the selected location and starts calculating a route.

Setting from information feeds

If the downloaded Infiniti Connection information feed has location data, you can set it as a destination. It is also possible to use various Infiniti Connection services set using the Infiniti Connection website such as “Destination Send-to-Vehicle”, “My Schedule” or “Journey Planner features”, etc. to set a destination.

For details of the services and settings, refer to the Infiniti Connection website: www.infiniticonnection.com (for U.S.)/ <https://canada.infiniticonnection.com> (for Canada), or contact the Infiniti Connection support line at 1-800-334-7858 (for U.S.) /1-855-892-7418 (for Canada).



1. Push **<INFO>**.
2. Highlight [Infiniti Connection] and push **<ENTER>**.

4. Setting destination

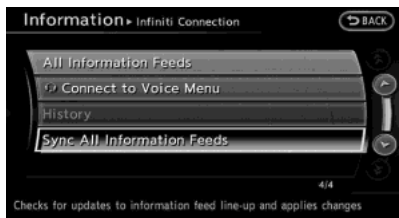

3. Highlight [Sync All Information Feeds] and push **<ENTER>**. A list screen is displayed. Highlight the preferred information feeds and push **<ENTER>**.

INFO:

The methods for setting a destination differ depending on the specific service (Destination Assistance, Destination Send-to-Vehicle and Connected Search, etc.) and Infiniti Connection services may be updated during ownership. Please see www.infiniticonnection.com (for U.S.)/<https://canada.infiniticonnection.com> (for Canada) for the latest features and services, as well as the most up-to-date user guide.

Searching by using IVR soft button on map



It is possible to set a destination by touching the IVR (Interactive Voice Response) soft button ① on the map. You can choose from the options provided by the voice guidance and speak your choice, or ask the Infiniti Connection Response Specialists directly to search for your destination.

 “Connecting to Interactive Voice Menu” (page 7-11)

SETTING PREVIOUS START POINT

It is possible to set the destination to the start point of a previous route guidance and have the system calculate a route.



1. Push **<DEST>**.
2. Highlight [Next Page] and push **<ENTER>**.

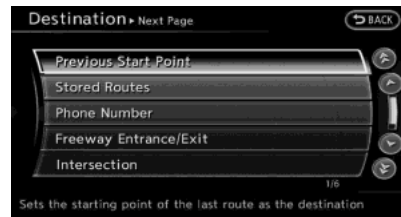

3. Highlight [Previous Start Point] and push **<ENTER>**.



- The previous start point is set as a destination, and the entire route is shown on the map. Highlight [Start] after confirming the location of the displayed destination, and push **<ENTER>**. The system sets the destination to the selected location and starts calculating a route.



INFO:

Even after setting a destination, the location of the destination can be adjusted, the route can be stored, etc.

 "Procedures after setting destination"
(page 5-2)



Voice command

- Push **<TALK>**  located on the steering wheel.

- After the tone sounds, speak a command.

To set a previous start point as the destination:

"Previous Start Point" (Alternate Command Mode)

SETTING FROM STORED ROUTES

It is possible to select a preferred route from the stored routes.



- Push **<DEST>**.
- Highlight [Next Page] and push **<ENTER>**.



- Highlight [Stored Routes] and push **<ENTER>**. A list screen is displayed.

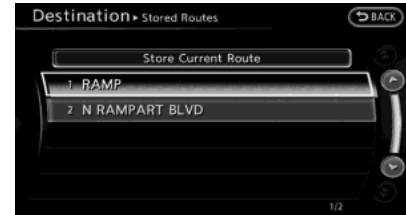

- Highlight the preferred route from the list and push **<ENTER>**. The route to the destination is set.

4. Setting destination



5. The entire route is shown on the map. Highlight [Start] after confirming the location of the displayed destination, and push **<ENTER>**. The system sets the destination to the selected location and starts calculating a route.

INFO:

- Even after setting a destination, the location of the destination can be adjusted, the location can be stored, etc.
 “Procedures after setting destination” (page 5-2)
- The stored route includes only locations (destination and waypoints) and route calculation conditions, not the route itself. Therefore, when the destination is set using a stored route, a different route may be suggested if the current vehicle location is different from the one when the route was

stored.

SETTING BY PHONE NUMBER

If the phone number of a facility is known, it is possible to search for a facility by entering the phone number, and have the system calculate a route.

INFO:

- Telephone numbers that were stored for stored destinations can also be used.
- If the area code of the specified telephone number does not exist in the map data, the system cannot search for the location.
- Only the locations included in the database in the map data can be searched by the phone number. Residential phone numbers cannot be used to search for a location.



1. Push **<DEST>**.
2. Highlight [Next Page] and push **<ENTER>**.



3. Highlight [Phone Number] and push **<ENTER>**. The telephone number input screen is displayed.



4. Enter the telephone number including the area code.
5. After finishing the entry, highlight [List] and push **<ENTER>**.
 “Number input screen”

4. Setting destination

(page 2-17)



6. A list screen is displayed if there are two or more search results. Highlight the preferred destination from the list and push **<ENTER>**.

A confirmation screen for the place name and the location is displayed, and the system starts calculating.



7. The entire route is shown on the map. Highlight [Start] after confirming the location of the displayed destination, and push **<ENTER>**. The system sets the

destination to the selected location and starts calculating a route.

INFO:

Even after setting a destination, the location of the destination can be adjusted, the route can be stored, etc.

-  "Procedures after setting destination" (page 5-2)

SETTING FREEWAY ENTRANCE/EXIT

It is possible to set the destination to an entrance or exit of a freeway and have the system calculate a route.



1. Push **<DEST>**.
2. Highlight [Next Page] and push **<ENTER>**.

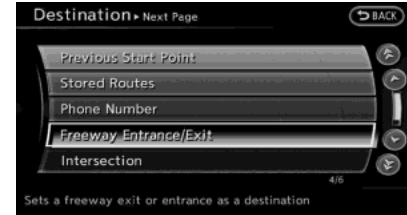

3. Highlight [Freeway Entrance/Exit] and push **<ENTER>**. A character input screen is displayed.



4. Enter the name of the freeway.
5. After finishing the entry, highlight [List] and push **<ENTER>**.

4. Setting destination

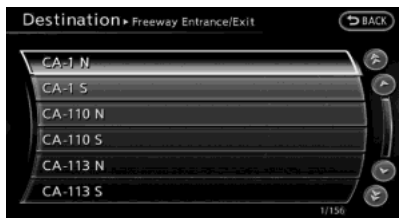

6. Highlight the freeway of the destination from the list, and push **<ENTER>**.



7. Highlight [Entrance] or [Exit] and push **<ENTER>**. A list screen is displayed.



8. Select the preferred destination from the list. The position of the selected location is displayed in the preview on the right side of the screen. Then, push **<ENTER>**.



INFO:

Select [By Distance] to sort the list by the nearest distance.



9. The entire route is shown on the map. Highlight [Start] after confirming the location of the displayed destination,

and push **<ENTER>**. The system sets the destination to the selected location and starts calculating a route.



INFO:

Even after setting a destination, the location of the destination can be adjusted, the route can be stored, etc.

"Procedures after setting destination" (page 5-2)

SETTING INTERSECTION

It is possible to set an intersection of any two streets as the destination and have the system calculate a route.



1. Push **<DEST>**.
2. Highlight [Next Page] and push **<ENTER>**.

4. Setting destination



3. Highlight [Intersection] and push **<ENTER>**. A character input screen is displayed.



4. Enter the name of the 1st street.
After finishing the entry, highlight [List] and push **<ENTER>**. A list screen is displayed.



5. Highlight a street as the 1st street from the list and push **<ENTER>**. A character input screen is displayed.



6. Enter the name of the 2nd street.
After finishing the entry, highlight [List] and push **<ENTER>**. A list screen is displayed.



7. Highlight a street as the 2nd street from the list and push **<ENTER>**.

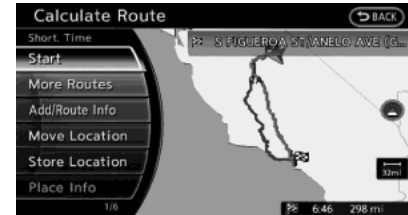

8. The entire route is shown on the map.
Highlight [Start] after confirming the location of the displayed destination, and push **<ENTER>**. The system sets the destination to the selected location and starts calculating a route.

4. Setting destination

INFO:

Even after setting a destination, the location of the destination can be adjusted, the route can be stored, etc.

 “Procedures after setting destination”
(page 5-2)

SETTING CITY CENTER

It is possible to set the center of a city as a destination and have the system calculate a route.



1. Push **<DEST>**.
2. Highlight [Next Page] and push **<ENTER>**.



3. Highlight [City Center] and push **<ENTER>**. A character input screen is displayed.



4. Enter the name of the city, highlight [List] and push **<ENTER>**. A list screen is displayed.

INFO:

Highlight [Last 5 Cities] and push **<ENTER>** to display the last 5 cities recently set as destinations.



5. Highlight the preferred destination from the list and push **<ENTER>**. The position of the selected location is displayed in the preview on the right side of the screen.

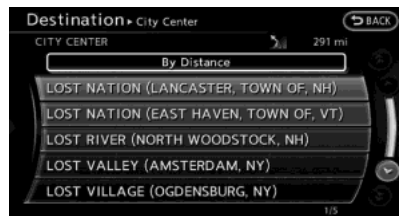

INFO:

Select [By Distance] to sort the list by the nearest distance.



- The selected destination is displayed at the center of the map. Highlight [Start] after confirming the location of the displayed destination, and push **<ENTER>**.

The system sets the destination to the selected location and starts calculating a route.

INFO:

Even after setting a destination, the location of the destination can be adjusted, the route can be stored, etc.

 “Procedures after setting destination” (page 5-2)

SETTING POINT ON MAP

It is possible to set a location scrolled to on the map as the destination and have the system calculate a route.



- Scroll the map, place the cross pointer over the preferred location, and push **<ENTER>**.

INFO:

- The map scale should be adjusted to search for a location more effectively.
- The point on the blinking road where the center of the cross pointer is located can be set as a destination.



- Highlight [New Dest.] and push **<ENTER>**.

INFO:

For the items other than [New Dest.], refer to “Map menu screen”.

 “Scrolled location map screen” (page 2-19)



- The system sets the destination to the selected location and starts calculating a route.

4. Setting destination

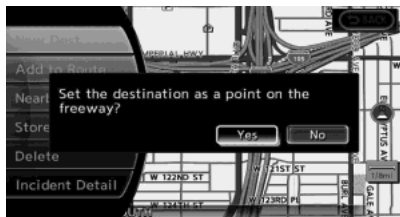

INFO:

If a point on a freeway is set as the destination, a confirmation message is displayed.

DELETE DESTINATION

It is possible to delete a destination and all waypoints that have already been set.



1. Push **<DEST>**.
2. Highlight [Next Page] and push **<ENTER>**. Select [Delete Destination] and push **<ENTER>**.



3. A confirmation message is displayed. Select [Yes] and push **<ENTER>**.
The destination and the waypoints are

deleted.

INFO:

The deleted destination and waypoints are not able to be reactivated.

Voice command

1. Push **<TALK >** on the steering wheel.
2. After the tone sounds, speak a command.

To delete a destination and all waypoints:

“Delete Destination” (Alternate Command Mode)

5 Route guidance

Procedures after setting destination	5-2	Editing route	5-15
Starting route guidance.....	5-2	Confirming route	5-20
Selecting route.....	5-3	Guidance settings.....	5-21
Confirming route	5-3	Recalculate route.....	5-22
Moving location of destination	5-5	Setting detour route	5-23
Storing location	5-5	Searching for detour route taking traffic information into consideration.....	5-24
Viewing information about searched location ...	5-6	Setting conditions for route calculation	5-25
About route guidance	5-7	Route guidance settings	5-27
Voice guidance during route guidance.....	5-7	Basic operation	5-27
Guidance screens and preview mode.....	5-8	Setting voice guidance at intersections.....	5-28
Guidance screen settings	5-9	Displaying small turn arrow on map	5-29
Route screen	5-13	Switching estimated arrival time display.....	5-29
Basic operation.....	5-13	Set average speeds	5-30
Canceling/reactivating route	5-14		

5. Route guidance

PROCEDURES AFTER SETTING DESTINATION

After performing a route search, the route guidance can be immediately started. Also, it is possible to confirm or change a route.



Available items after setting destination

- [Start]: Starts route guidance to the selected destination.
☞ "Starting route guidance" (page 5-2)
- [More Routes]: Displays 3 alternative routes.
☞ "Selecting route" (page 5-3)
- [Add/Route Info]: Displays the route information. A destination or a waypoint can also be added.
☞ "Confirming route" (page 5-3)

- [Move Location]: Displays a map screen. The location of the destination can be adjusted.
☞ "Moving location of destination" (page 5-5)
- [Store Location]: Stores the location in the Address Book.
☞ "Storing location" (page 5-5)
- [Place Info]: Displays information about the facility that has been set as the destination, if it is included in the map data.
☞ "Viewing information about searched location" (page 5-6)



INFO:

- If no operations have been performed on the system for several seconds, [Start] is automatically selected, and the system starts route guidance.
- When using waypoints, [More Routes] is disabled. After the route is started, push <ROUTE> then select [Edit/Add to Route] to change the route between each waypoint.
- The same screen as when [Move Location] is selected can be displayed with the following

operations:

- Touching the map screen
- Pushing the directional buttons except for the up/down button (INFINITI controller with directional buttons)
- Pushing the slide switch except in the upward/downward direction (INFINITI controller without directional buttons)

STARTING ROUTE GUIDANCE



1. Highlight [Start] and push <ENTER>. Route guidance starts.

SELECTING ROUTE



1. Highlight [More Routes] and push **<ENTER>**.



2. Highlight the preferred route condition and push **<ENTER>**.
3. The display automatically returns to the map screen.

Available route conditions

- [Short. Time] (purple):
Prioritizes by the shortest time.
- [Min. Freeway] (orange):
Minimizes the use of freeways.
- [Short. Dist.] (green):
Prioritizes by the shortest distance.



INFO:

- When the route is selected, a preview is displayed on the right side of the screen.
- The 3 routes may not always be different.

CONFIRMING ROUTE



1. Highlight [Add/Route Info] and push **<ENTER>**.
2. Highlight the preferred information item and push **<ENTER>**.

3. Push **<BACK>** to return to the previous screen.



Available information

- [Turn List]:
Displays the details of the suggested route.
☞ "Using turn list" (page 5-20)
- [Preview]:
The system will trace the planned route going forward or in reverse.
☞ "Using route preview" (page 5-21)
- [Add Way Pt.]:
Edits the route by adding a waypoint or a destination.
☞ "Adding destination or waypoint" (page 5-4)
- [Store Route]:
Stores a calculated route. A maximum of 5 routes can be stored. Stored routes

5. Route guidance

can be easily retrieved and set as the suggested route.

 “Storing route” (page 6-5)

- [Map Scroll]:

Displays a map screen where the location of the destination can be confirmed.

The same screen as when [Map Scroll] is touched can be displayed with the following operations:

- Touching the map screen.
- Pushing the directional buttons except for the up/down button (INFINITI controller with directional buttons).
- Pushing the slide switch except in the upward/downward direction (INFINITI controller without directional buttons).

Adding destination or waypoint

Before starting route guidance, destinations and/or waypoints can be added. A total of 6 destinations or waypoints can be set.



1. Highlight [Add Way Pt.] and push **<ENTER>**.

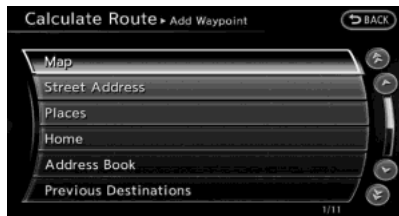

2. Set additional destinations or waypoints and push **<ENTER>**.

The method of searching for a location is the same as the one for a destination.

 “4. Setting destination”

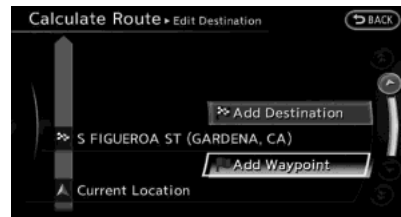

3. Highlight [Add Destination] or [Add Waypoint] and push **<ENTER>**.



4. The system starts calculating a route that includes the added destination or waypoint. When the calculation is finished, the route is displayed.



INFO:

- If a waypoint was added, [More Routes] cannot be selected.

5. Route guidance

- If a destination was added, the prior destination becomes a waypoint.

MOVING LOCATION OF DESTINATION

The location of the destination can be adjusted by moving the cross pointer across the map.



1. Highlight [Move Location] and push **<ENTER>**.



INFO:

The screen for adjusting the location also changes by touching the map screen displayed on the right side of the screen.



2. Adjust the location by moving the cross pointer across the map and push **<ENTER>**. The location of the destination is modified.



INFO:

- The map scale can be changed by turning the center dial or touching the scale icon. The map scale can also be changed by pressing **<ZOOM IN>/<ZOOM OUT>** (if so equipped).
- The same screen as when [Move Location] is touched can be displayed with the following operations:
 - Touching the map screen.
 - Pushing the directional buttons except up/down buttons (INFINITI controller with directional buttons).

- Pushing the slide switch except upward/downward (INFINITI controller without directional buttons).

STORING LOCATION

A searched location can be stored in the Address Book. Then it can be easily retrieved and set as a destination (or waypoint).



1. Highlight [Store Location] and push **<ENTER>**.

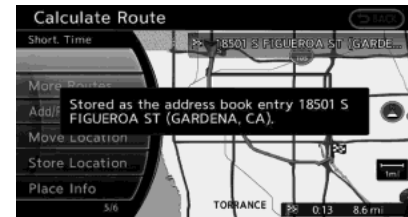

5. Route guidance

2. The location is stored in the Address Book. The corresponding icon is displayed at the set location on the map.

VIEWING INFORMATION ABOUT SEARCHED LOCATION

Information (street address and phone number) about places stored in the map data can be displayed.



1. Select [Place Info] and push **<ENTER>**.

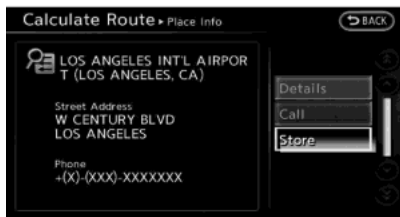

2. Information about the location is displayed.
3. Push **<BACK>** to return to the previous screen.

INFO:

- If [Call] is displayed on the right side of the screen, it is possible to call the location indicated.
- The Bluetooth® Hands-Free Phone system is required to be active and the cellular phone connected to call the location indicated.
- Information about locations is not displayed while driving.

ABOUT ROUTE GUIDANCE

After setting the route, select [Start] to begin route guidance.

Throughout route guidance, the system navigates you through the guide points using visual and voice guidance.



CAUTION

- The navigation system's visual and voice guidance is for reference purposes only. The contents of the guidance may be inappropriate depending on the situation.
- Follow all traffic regulations when driving along the suggested route (e.g., one-way traffic).

 "Route guidance" (page 10-10)

VOICE GUIDANCE DURING ROUTE GUIDANCE

When approaching a guide point (intersection or corner), destination, etc. during route guidance, voice guidance announces the remaining distance and/or turning direction. Push **<VOICE>** to repeat voice guidance.

5. Route guidance

Example of voice guidance

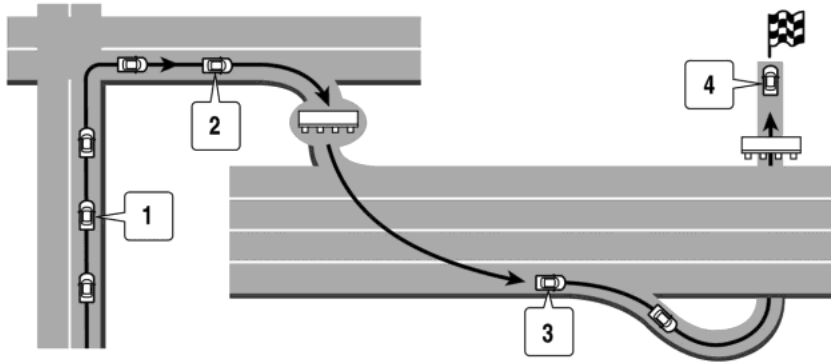

- ① “In about one quarter mile (400 meters), right (left) turn.”
“Right (left) turn ahead.”
- ② “In about one quarter mile (400 meters) freeway entrance on your right onto (road number and direction).”
“Freeway entrance on your right onto (road number and direction).”
- ③ “In about one mile (1.6 kilometers), exit on your right.”

“Exit on your right.”

- ④ “You have arrived at your destination.
Ending route guidance.”

GUIDANCE SCREENS AND PREVIEW MODE

Route guidance displays map screens and various information according to the situation.



When route guidance starts, the Small Turn Arrow on Map is displayed in the upper left corner of the map screen. This arrow indicates the turning direction at the next guide point (corner or intersection). The distance is also displayed. At the top of the screen, the distance to the next guide point and the name of the next street to turn on to are displayed. Also, there may be cases that next street names are announced. The Small Turn Arrow on Map can be enabled or disabled by the user.

 “Displaying small turn arrow on map”
(page 5-29)

Enlarged intersection view

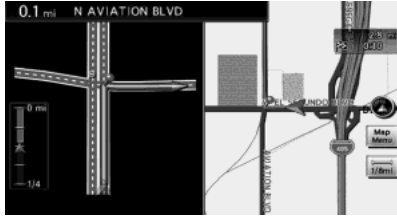

When approaching a guide point, the system automatically changes to the split screen and shows an enlarged view of the intersection on the left screen. After passing through the intersection, the system automatically returns to the full screen mode. To switch to the full screen mode while the enlarged intersection view is displayed, push **<MAP>**. Pushing **<MAP>** again displays the enlarged intersection view.

Junction guidance



While driving on a freeway, when the vehicle is approximately 1 mile (approximately 1.6 km) from a junction, the system automatically switches to the split screen and displays an enlarged view of the junction (3D) on the left screen. After passing the junction, the system automatically returns to the full screen mode. To switch to the full screen mode while the enlarged junction view is displayed, push **<MAP>**.

Turn list



Depending on the setting, the system can constantly display the split screen and show the turn list on the left screen. When approaching a guide point, the left screen automatically switches to an enlarged view of the intersection. To switch to the full screen mode, push **<MAP>**. Pushing **<MAP>** again displays the turn list.

“Guidance screen settings” (page 5-9)

GUIDANCE SCREEN SETTINGS

The guidance screen can be displayed at all times even when the vehicle is located away from the guide point. Various types of screens can be set.

5. Route guidance

Split screen settings

The display setting on the left-hand side screen shown during route guidance can be changed.

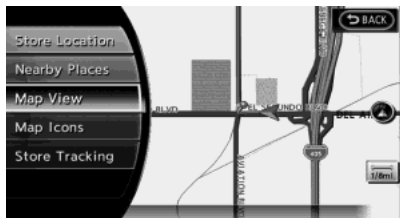

1. Push **<ENTER>** while the current location map screen is displayed.
2. Highlight [Map View] and push **<ENTER>**.

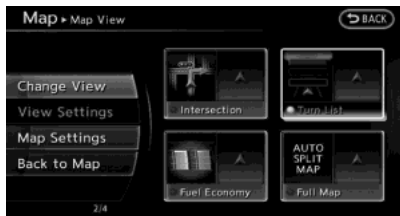

3. Highlight [View Settings] and push **<ENTER>**.

4. Highlight the preferred screen and push **<ENTER>**. The indicator of the selected screen illuminates.

Intersection:

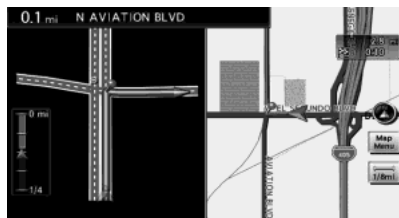

The map screen and the enlarged intersection view can be displayed at the same time.

Push **<MAP>** to switch to the full map screen.

Turn list:



The list screen for showing the guide points to the destination and the map screen can be displayed at the same time. An enlarged intersection view is automatically displayed when the vehicle approaches the guide point.

The turn list can be scrolled using the center dial, the main directional buttons, the slide switch or by touching the up/down button on the screen.

Push **<MAP>** to switch to the full map screen. Push **<MAP>** again to display the turn list.

Fuel Economy:

The current fuel consumption rate, average fuel consumption rate, instantaneous consumption rate and distance to empty can be displayed on the map screen. An enlarged intersection view is automatically displayed when the vehicle approaches the guide point.

Push **<MAP>** to switch to the full map screen.

Push **<MAP>** again to display the fuel economy screen. When approaching a guide point, the enlarged view of the intersection is automatically displayed. To

5. Route guidance

display the fuel economy information, push **<MAP>**.

To display the map screen, push **<MAP>** again.

! NOTE:

Use the values displayed on the fuel economy screen as a guide. When the fuel gauge indicates empty or the low fuel warning light illuminates even if the distance to empty reading indicates a sufficient amount of fuel remains, refuel the vehicle as soon as possible.

Full map:

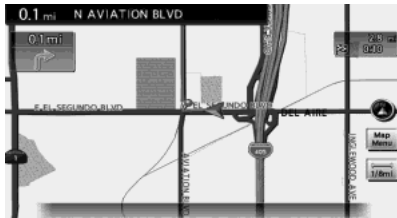

The current location map is displayed. An enlarged intersection view is automatically displayed when the vehicle approaches the guide point.

When an enlarged intersection view is displayed, pushing **<MAP>** returns to the

map screen.

Show exit information on freeways

When the vehicle travels on a highway or a toll road, the display automatically provides exit information in the turn list.

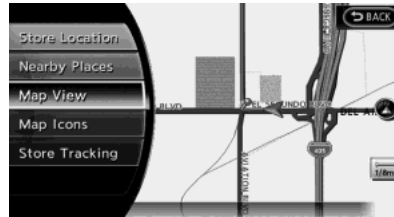

1. Push **<ENTER>** while the current location map screen is displayed.
2. Highlight [Map View] and push **<ENTER>**.

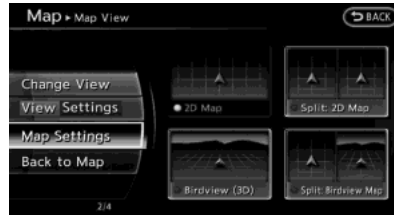

3. Highlight [Map Settings] and push **<ENTER>**.



4. Highlight [Show all Freeway Exits on Route] or [Auto. Show Turn List on Freeway] and push **<ENTER>**. The indicator illuminates when the item is set.
5. Push **<MAP>** to return to the current location map screen.

Showing freeway exit information:



When [Show all Freeway Exits on Route] is set to ON and the route includes the

5. Route guidance

freeway or toll road, all exits along the route which have exit information will be shown in the turn list. The exit information is shown as icons.

Displaying turn list automatically on freeway:



When [Auto. Show Turn List on Freeway] is set to ON, the turn list will be automatically displayed while the vehicle travels on a freeway or toll road.

Selecting a waypoint from the exit information list:

When exit information is displayed on the turn list, a waypoint to a facility located near the freeway exit can be set as a waypoint.



1. Highlight the exit where the exit information icon is displayed, and push **<ENTER>**. The category list screen is displayed.

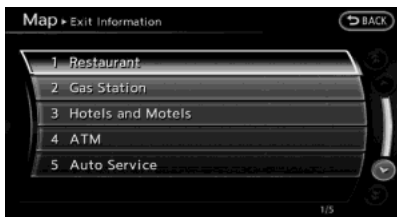

2. Highlight the landmark category and push **<ENTER>**. The list screen for showing facilities located near the freeway exit is displayed.



3. Highlight the preferred facility for the waypoint and push **<ENTER>**.



4. The waypoint is set, and the route search is performed.
 "Procedures after setting destination" (page 5-2)

ROUTE SCREEN

**WARNING**

Always stop the vehicle in a safe location before modifying the route conditions.

Modifying the route conditions while driving may cause an accident.

During route guidance, the route conditions can be modified and the route information can be confirmed. Set route conditions according to personal preference.



BASIC OPERATION

1. Push **<ROUTE>**.
2. Highlight the preferred setting item and push **<ENTER>**.
3. Push **<MAP>** to return to the current location map screen.

Available setting items

- [Cancel Route/Resume Route]:
Cancels the current route guidance. A canceled route can also be reactivated. If the suggested route is canceled, [Cancel Route] changes to [Resume Route].
☞ “Canceling/reactivating route” (page 5-14)
- [Edit/Add to Route]:
Edit or add a destination or waypoints to the route that is already set.
☞ “Editing route” (page 5-15)
- [Route Info]:
Confirm the route by the route information or simulation. The confirmed route can also be stored.
☞ “Confirming route” (page 5-20)
- [Guidance Settings]:
Activates or deactivates route, voice guidance and/or traffic announcement and adjust the volume level of voice guidance.
☞ “Guidance settings” (page 5-21)
- [Recalculate]:
Manually search for the route again after changing the search condition and have the system calculate a route.
☞ “Recalculate route” (page 5-22)
- [Detour]:
A detour of a specified distance can be calculated.
☞ “Setting detour route” (page 5-23)
- [Traffic Detour]:
Manually search for an alternative detour route taking the traffic information into consideration.
☞ “Searching for detour route taking traffic information into consideration” (page 5-24)
- [Route Settings]:
Changes the route calculation conditions anywhere along the route.
☞ “Setting conditions for route calculation” (page 5-25)

5. Route guidance

CANCELING/REACTIVATING ROUTE

A route that is already set can be canceled at any time. If a route is deleted, the destination and waypoints are also canceled.

It is also possible to reactivate a canceled route.



INFO:

Canceling a route does not delete the destination and waypoint information completely.

"Delete destination" (page 4-24)

Canceling route



1. Push **<ROUTE>**.
2. Highlight [Cancel Route] and push **<ENTER>**.

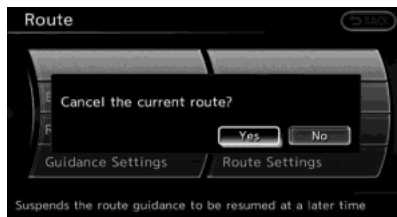

3. A confirmation message is displayed. Highlight [Yes] and push **<ENTER>**. The route is canceled along with the destination and waypoints.



Voice command

1. Push **<TALK < >** located on the steering wheel.
2. After the tone sounds, speak a command.

To cancel a route:

"Cancel Route" (Alternate Command Mode)

Reactivating route



1. Push **<ROUTE>**.
2. Highlight [Resume Route] and push **<ENTER>**.



3. A confirmation message is displayed. Highlight [Yes] and push **<ENTER>**. The canceled route is reactivated.

INFO:

If a new route is set, the canceled route cannot be reactivated.





EDITING ROUTE

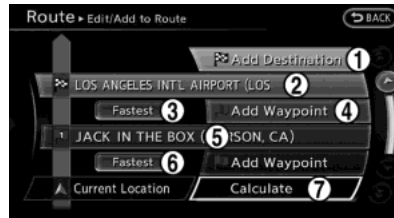



1. Push **<ROUTE>**.
2. Highlight [Edit/Add to Route] and push **<ENTER>**.
3. Highlight the preferred condition and push **<ENTER>**.
4. Push **<BACK>** to return to the previous screen. Push **<MAP>** to return to the current location map screen.



Available setting items

- ① [Add Destination]:
 “Setting destination or waypoint” (page 5-15)
- ② Current destination:
 Changes or deletes the destination.
 “Editing/deleting destination or waypoint” (page 5-17)
- ③ Condition for calculating a route to the destination:
 Changes the conditions for calculating a route to the destination.
 “Changing route calculation conditions” (page 5-19)
- ④ [Add Waypoint]:
 “Setting destination or waypoint” (page 5-15)

- ⑤ Current waypoint:
 Changes or deletes the waypoint.
 “Editing/deleting destination or waypoint” (page 5-17)
- ⑥ Condition for calculating a route to a waypoint:
 Changes the conditions for calculating a route to a waypoint.
 “Changing route calculation conditions” (page 5-19)
- ⑦ [Calculate]:
 Manually search for the route again after changing the search conditions and have the system calculate a route.
 “Changing route calculation conditions” (page 5-19)

Setting destination or waypoint

A destination or waypoint can be added to the route that has already been set. A total of 6 destinations or waypoints can be set.

5. Route guidance

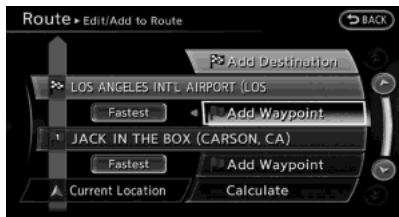

1. Push **<ROUTE>**.
2. Highlight [Edit/Add to Route] and push **<ENTER>**.
3. Highlight [Add Destination] or [Add Waypoint] and push **<ENTER>**.

If [Add Destination] is selected, the current destination changes to a waypoint.

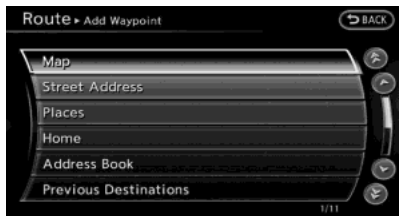

4. Set a destination or waypoint. The method of searching for a destination or waypoint is the same as the one for a

destination.

“4. Setting destination”

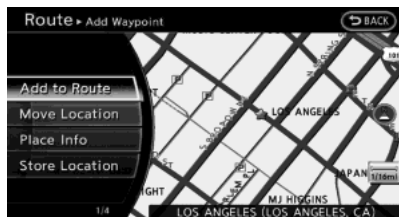

5. The selected location is displayed at the center of the map. Highlight [Add to Route] after confirming the location and push **<ENTER>**.

INFO:

Even after setting a destination/waypoint, the destination/waypoint location can be adjusted, the route can be stored, etc.

“Editing/deleting destination or waypoint” (page 5-17)

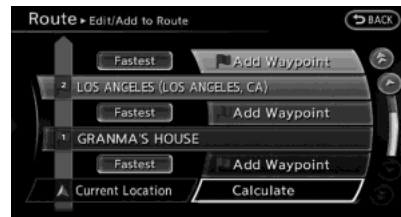

6. Return to the [Edit Route] screen. Set the route conditions as necessary.
7. Highlight [Calculate] and push **<ENTER>**. The system will recalculate the routes. After the route search is completed, the display will automatically return to the current location map screen.

INFO:

- The prior route is automatically deleted.
- Added waypoints and search conditions will not be taken into consideration for the route calculation until [Calculate] is highlighted and **<ENTER>** is pushed.

Editing/deleting destination or waypoint

The destination or waypoint that has already been set can be modified or deleted.

If a location is modified or deleted when a suggested route is already set, the prior suggested route will be recalculated accordingly.



1. Push **<ROUTE>**.
2. Highlight [Edit/Add to Route] and push **<ENTER>**.
3. Highlight a destination or waypoint that is already set and push **<ENTER>**.

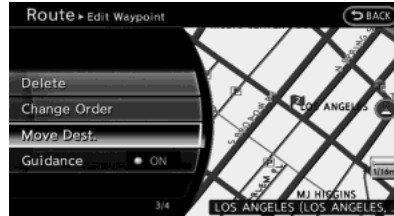

4. Highlight [Move Dest.] to modify the location and push **<ENTER>**.
 Ⓜ “Moving location of destination”
 (page 5-5)



5. Highlight [Delete] and push **<ENTER>** to delete the location.

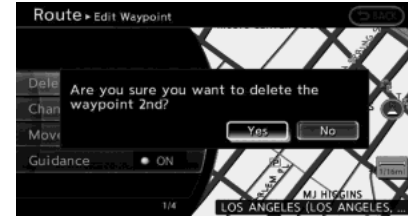

6. A confirmation message is displayed. Confirm the contents of the message, highlight [Yes] and push **<ENTER>**. The destination or waypoint is deleted from the route. Return to the [Edit Route] screen.

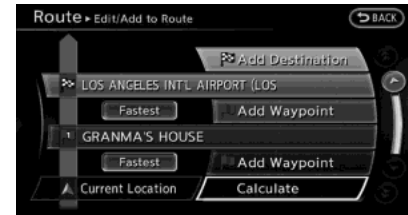

7. By highlighting [Calculate] and pushing **<ENTER>**, the system will recalculate the routes. After the route search is completed, the display will automatically return to the current location map screen.

5. Route guidance

INFO:

- If the destination is deleted, the final waypoint of the route becomes the destination.
- Even if the map screen is touched, the same map screen as when [Move Dest.] is selected is displayed.

Changing order of destination and waypoints

The order of a destination and waypoints that have already been set can be changed.

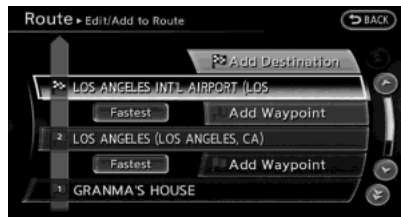

1. Push **<ROUTE>**.
2. Highlight [Edit/Add to Route] and push **<ENTER>**.
3. Highlight a destination or waypoint that is already set and push **<ENTER>**.

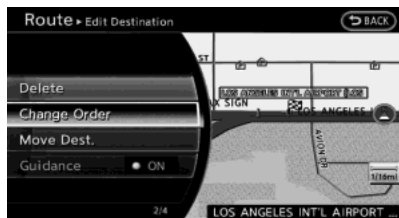

4. Highlight [Change Order] and push **<ENTER>**. A list of the destination and waypoints is displayed.



5. Highlight a preferred destination or waypoint to replace the previously selected destination or waypoint and push **<ENTER>**.



6. A message is displayed and the order of the destination or waypoint is changed.

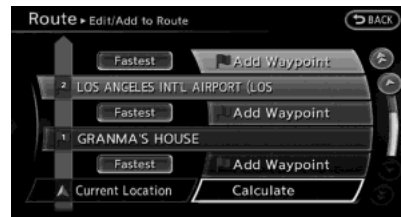

7. By highlighting [Calculate] and pushing **<ENTER>**, the system will recalculate the routes. After the route search is complete, the display will automatically return to the current location map screen.

Changing route calculation conditions

Each section of the route between waypoints can have different route calculation conditions. After setting these conditions, the entire route can be recalculated.



1. Push **<ROUTE>**.
2. Highlight [Edit/Add to Route] and push **<ENTER>**.
3. Highlight the preferred section of the route to the destination or waypoint and push **<ENTER>**.

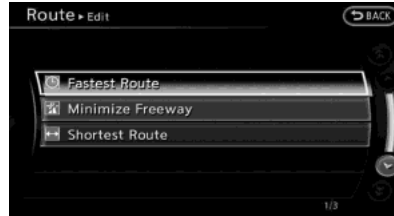

4. Highlight the preferred condition and push **<ENTER>**.

Available conditions

- : [Fastest Route]
- : [Minimize Freeway]
- : [Shortest Route]

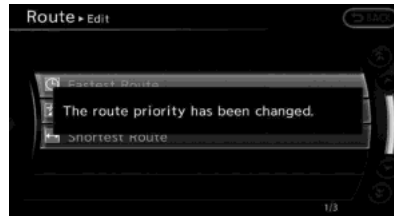

5. The conditions have been changed and the display returns to the [Edit Route] screen.

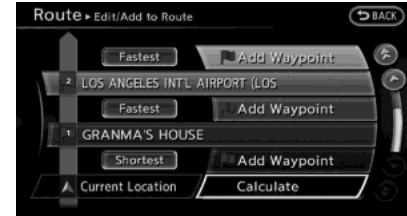

6. By highlighting [Calculate] and pushing **<ENTER>**, the system will recalculate the routes. After the route search is completed, the display will automatically return to the current location map screen.

INFO:

- The recalculated route may not be the shortest route because the system prioritizes roads that are easy to drive for safety reasons.
- If the route conditions are set from [Route Settings], all sections in the route are subject to the same route conditions. This applies even if different route conditions have been set for different sections in [Edit Route].

5. Route guidance

CONFIRMING ROUTE

When the suggested route is displayed after calculation, the route information can be confirmed or the suggested route can be simulated.

Basic operation

1. Push **<ROUTE>**.



2. Highlight [Route Info] and push **<ENTER>**.



3. Highlight the preferred item and push **<ENTER>**.

Available setting items

- [Turn List]:
Displays the details of the suggested route.
☞ "Using turn list" (page 5-20)
- [Preview]:
The system will trace the planned route going forward or in reverse.
☞ "Using route preview" (page 5-21)
- [Simulation]:
Displays a simulation of the suggested route. This function provides a detailed image of the route with voice guidance.
☞ "Confirming route by simulation" (page 5-21)
- [Store Route]:
Stores a calculated route. A maximum of 5 routes can be stored. Stored routes can be easily retrieved and set as the suggested route.
☞ "Storing route" (page 6-5)
- [Map Scroll]:
Displays a map screen where the location of the destination can be confirmed.

The same screen as when [Map Scroll] is touched can be displayed with the following operations:

- Touching the map screen.
- Pushing the directional buttons except for the up/down buttons (INFINITI controller with directional buttons).
- Pushing the slide switch except in the upward/downward direction (INFINITI controller without directional buttons).

Using turn list



1. Highlight [Turn List] and push **<ENTER>**.
2. The information (e.g., intersections) can be confirmed on the route to the destination by scrolling the screen pushing the up and down switches of the main directional buttons, pushing the slide switch upward or downward or rotating the center dial.

3. Push **<MAP>** to return to the current location map screen.

Using route preview

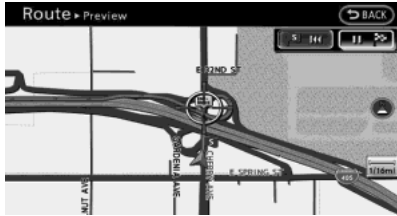

1. Highlight [Preview] and push **<ENTER>**.
2. Highlight the preferred key and push **<ENTER>**.

: Moves forward in the direction of the destination.

: Moves backward in the direction of the starting point.

: Pauses the route preview.

3. Push **<MAP>** to return to the current location map screen.



INFO:

During the route preview, you can change the map scale by turning the center dial. While the map scale is being changed, the route preview is

temporarily stopped.

During the route preview, the map scale can be changed by pushing **<ZOOM IN>/<ZOOM OUT>** (if so equipped). While the map scale is being changed, the route preview is temporarily stopped.

Confirming route by simulation

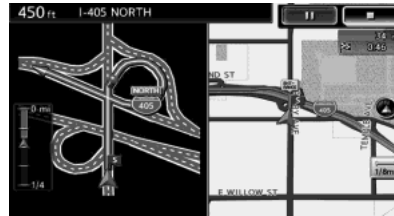

1. Highlight [Simulation] and push **<ENTER>**.
2. Highlight the preferred key and push **<ENTER>**.

: Pauses the simulation.

: Resumes the simulation.

: Ends the simulation.

3. Push **<MAP>** to return to the current location map screen.



INFO:

During the route preview, you can change the map scale by turning the center dial. While the map scale is being changed, the simulation is temporarily stopped.

During the route preview, the map scale can be changed by pushing **<ZOOM IN>/<ZOOM OUT>** (if so equipped), the simulation is temporarily stopped.

GUIDANCE SETTINGS

Various guidance settings can be set.

Basic operation

1. Push **<ROUTE>**.



2. Highlight [Guidance Settings] and push **<ENTER>**.
3. Highlight the preferred item and push **<ENTER>**.

5. Route guidance

4. Push **<BACK>** to return to the previous screen. Push **<MAP>** to return to the current location map screen.

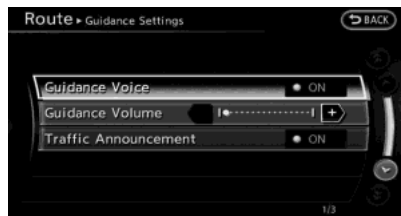

Available setting items

- [Guidance Voice]: Activates or deactivates voice guidance. The indicator illuminates if voice guidance is activated.
- [Guidance Volume]: Adjusts the volume level of voice guidance.
- [Traffic Announcement]: Provides the announcement of a traffic information event on the route.

Voice command

1. Push **<TALK>** located on the steering wheel.

2. After the tone sounds, speak a command.

To turn the Voice Guidance ON or OFF:
“Voice Guidance On/Off” (Alternate Command Mode)

RECALCULATE ROUTE

A route can be manually searched again after changing the search condition. When the vehicle deviates from the suggested route, the route from the current location to the destination is automatically searched again.

Manually re-searching route

1. Push **<ROUTE>**.



2. Highlight [Recalculate] and push **<ENTER>**.

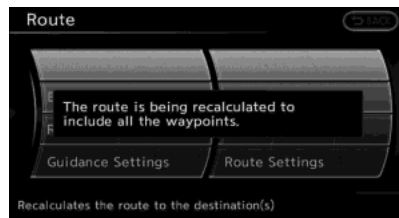

3. A message is displayed, and the route is recalculated.

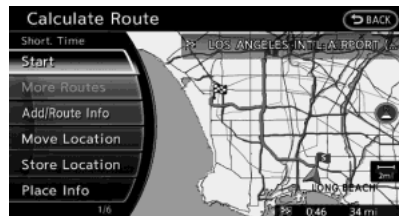

4. Set the route conditions. After finishing the setting, highlight [Start] and push **<ENTER>**.

 “Procedures after setting destination” (page 5-2)

INFO:

When a waypoint has been set on the route, the system will search for only one route even if

route recalculation is performed.

Setting Auto Reroute

1. Push **<ROUTE>**.



2. Highlight [Route Settings] and push **<ENTER>**.

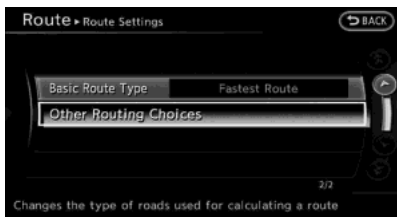

3. Highlight [Other Routing Choices] and push **<ENTER>**.

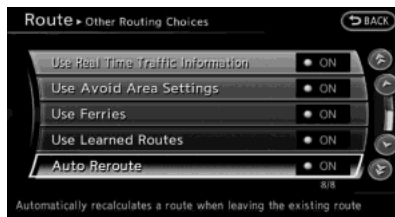

4. Highlight [Auto Reroute] and push **<ENTER>**. The indicator illuminates. When the current location map screen or route setting screen is displayed, the system recalculates a route with the set conditions.
 “Setting conditions for route calculation” (page 5-25)

SETTING DETOUR ROUTE

To detour from the suggested route, a route detouring for a specified distance can be calculated.

1. Push **<ROUTE>**.



2. Highlight [Detour] and push **<ENTER>**.

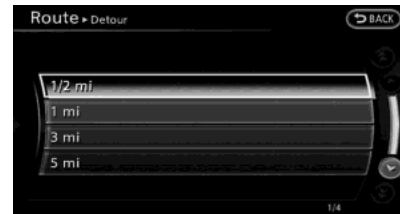

3. Highlight a detour distance and push **<ENTER>**.

After calculating the detour, the system displays the detour route on the map.

INFO:

- When the vehicle has deviated from the suggested route, [Detour] cannot be selected.

5. Route guidance

- If the system cannot calculate a detour with the specified conditions, it displays the previous suggested route.
- If the vehicle is traveling very fast, the detour route may start from a location that the vehicle has already passed.

SEARCHING FOR DETOUR ROUTE TAKING TRAFFIC INFORMATION INTO CONSIDERATION

When a serious traffic event occurs on the route, or if the system finds a faster route, a detour alert will pop up automatically. If the automatic alert is not noticed, a detour can also be manually searched.

1. Push **<ROUTE>**.



2. Highlight [Traffic Detour] and push **<ENTER>**.

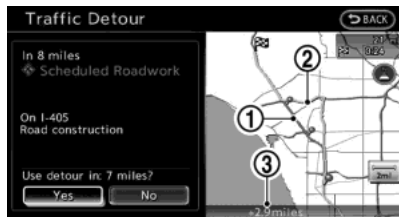

3. When the detour search is successful, detailed information about the detour route (left screen) and the comparison screen of the two routes (right screen) are displayed.

- ① Original route (yellow)
- ② Detour route (pink)
- ③ The change of distance and estimated travel time to destination when the detour route is taken.

4. To accept the suggested detour route, highlight [Yes], and then push **<ENTER>**.

INFO:

- If no route is set, or [Use Real Time Traffic Information] is turned off, this function cannot be operated.

- If a detour route is not selected and no further action is performed, the detour route will be automatically canceled.
- The detour suggestion can be retrieved even after the message disappears by manually selecting [Traffic Detour]. The system will then search for the detour again and suggests a detour if one is available at that time.
- Without a subscription to a NavTraffic broadcast, it will not be possible to get a traffic detour or apply settings for functions related to traffic information. A message appears when a related menu item is selected.
 "Notes on NavTraffic information" (page 10-14)

Automatic detour guidance

When [Auto Reroute] and [Use Real Time Traffic Information] are turned on in the detailed route settings, a message will automatically pop up when the system finds a detour.

 "Detailed route settings" (page 5-26)



1. If a traffic jam or a serious traffic problem occurs on the route while driving along the suggested route, the automatic detour route search starts and a message pops up if a detour is found.
2. To accept the suggested detour route, highlight [Yes] and push **<ENTER>**.



INFO:

- If no operation is performed for one minute after the message is displayed, the message disappears. The detour will not be accepted, and the current suggested route will remain unchanged.
- When [Traffic Announcement] is turned on in the guidance settings, the system will announce voice guidance at the same time that the message appears on the screen.

“Guidance settings” (page 5-21)

SETTING CONDITIONS FOR ROUTE CALCULATION

Search condition settings

The route can be recalculated after changing the route calculation conditions anywhere along the route.

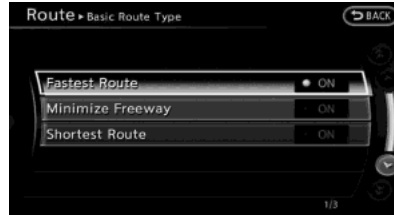

Basic operation:

1. Push **<ROUTE>**.
2. Highlight [Route Settings] and push **<ENTER>**.
3. Highlight [Basic Route Type] and push **<ENTER>**.
4. Highlight the preferred condition and push **<ENTER>**. The indicator for the selected condition illuminates.

5. When the conditions are set, the system starts calculating the route with the new conditions, and the current location map screen is displayed.

Available conditions

- [Fastest Route]:
Prioritizes by the fastest time.
- [Minimize Freeway]:
Minimizes the use of motorways.
- [Shortest Route]:
Prioritizes by the shortest route.



INFO:

Only one of these conditions can be utilized at a time.



Voice command

1. Push **<TALK <E>** located on the steering wheel.
2. After the tone sounds, speak a command.

To set conditions for the route calculation (Alternate Command Mode):

“Fastest Route”

“Minimize Freeway Route”

5. Route guidance

“Shortest Route”

Detailed route settings

Detailed conditions can be set for the route calculation.

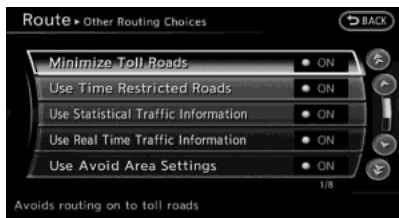

Basic operation:

1. Push **<ROUTE>**.
2. Highlight [Route Settings] and push **<ENTER>**.
3. Highlight [Other Routing Choices] and push **<ENTER>**.
4. Highlight the preferred condition and push **<ENTER>**. The indicator for the selected condition illuminates.
5. If [Route Settings] is exited after changing the settings, the system starts calculating the route with the new conditions.

Available setting items

- [Minimize Toll Roads]: Minimizes the use of toll roads.
- [Use Time Restricted Roads]: Uses any roads subject to time restrictions.
- [Use Statistical Traffic Information]: Uses statistical traffic information that is stored in the map data.
- [Use Real Time Traffic Information]: Uses the latest traffic information received via the SiriusXM broadcast.
- [Use Avoid Area Settings]: Enables the avoid area setting.
- [Use Ferries]: Includes the use of ferries.
- [Use Learned Routes]: Uses the roads that are most frequently traveled with the help of self-learning technology.
- [Auto Reroute]: If the vehicle deviates from the suggested route, the system automatically recalculates a route that leads the vehicle to the suggested route.

INFO:

- The recalculated route may not be the shortest route because the system prioritizes roads that are easy to drive for safety reasons.
- If route conditions are set from [Route Settings], all sections in the route are subject to the same route conditions even though different route conditions have been set for different sections in [Edit/Add to Route].
- If [Use Time Restricted Roads] is deactivated, the system calculates a route without any consideration of the regulations concerning the time or day of the week. Therefore, the suggested route may include a road subject to traffic regulations concerning the time or day of the week. When driving along the route, always follow all traffic regulations regardless of whether [Use Time Restricted Roads] is set to on or off.
- If the system cannot calculate any alternative routes, it displays the previous route.
- If the vehicle greatly deviates from the suggested route, the system calculates a new route.

- Statistical traffic information is based on previous traffic data. When the traffic situation rapidly changes due to unexpected accidents, construction work, traffic restrictions, emergencies, etc., the prediction accuracy of the system may be reduced.
- Traffic jam information displayed on the map screen is not statistical traffic information.
- When [Use Statistical Traffic Information] is turned on, the system may lead to a road where a traffic jam occurs or to a detour even though the shortest route does not have a traffic jam.
- Even when [Use Real Time Traffic Information] is turned on, if traffic information has not been provided for the area, sometimes it is possible that a detour will not be indicated in a location where a traffic jam occurs.
- The system may not lead to a detour if traffic closure or a traffic jam occurs far from the present location.
- The system calculates to reduce the time required for the entire route from the start to the destination. If there are no appropriate routes, the system may lead to a route where a traffic jam occurs instead of leading to a detour.
- This system can learn and memorize the route that is most frequently used. However, despite driving on the same route several times so that the system can learn the route, the system may have difficulty learning the route under the following conditions.
 - [Use Time Restricted Roads] is set to on.
 - [Use Real Time Traffic Information] is set to on.

ROUTE GUIDANCE SETTINGS

Various guidance information can be set to be played during route guidance and the route and/or voice guidance can be activated or deactivated.

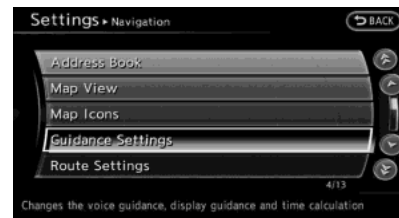

BASIC OPERATION

1. Push **<SETTING>**.
2. Highlight [Navigation] and push **<ENTER>**.
3. Highlight [Guidance Settings] and push **<ENTER>**.
4. Highlight the preferred item and push **<ENTER>**.
5. Push **<BACK>** to return to the previous screen. Push **<MAP>** to return to the current location map screen.

5. Route guidance



Available setting items

- [Guidance Volume]:
Adjusts the volume level of voice guidance.
☞ “Guidance settings” (page 5-21)
- [Guidance Voice]:
Activates or deactivates voice guidance.
The indicator illuminates if voice guidance is activated.
☞ “Guidance settings” (page 5-21)
- [Traffic Announcement]:
Provides an announcement of a traffic information event on the route.
☞ “Guidance settings” (page 5-21)
- [Voice Guidance Settings]:
Sets advanced settings for the voice guidance announced at guide points.
☞ “Route guidance settings”

(page 5-27)

- [Guidance Display Settings]:
Activates or deactivates small turn arrow display on the map.
☞ “Displaying small turn arrow on map” (page 5-29)
- [Estimated Time]:
Switches the display of the estimated travel time to the destination or waypoint that is displayed on the map screen.
☞ “Switching estimated arrival time display” (page 5-29)
- [Others]:
 - [Set Average Speeds]:
Sets an average vehicle speed for each type of road, which is reflected in the calculation of the required time to the destination.
☞ “Set average speeds” (page 5-30)
 - [Auto Reroute]:
If the vehicle deviates from the suggested route, the system automatically recalculates a route that leads the vehicle to the suggested route.
☞ “Setting Auto Reroute” (page 5-23)

SETTING VOICE GUIDANCE AT INTERSECTIONS

1. Push **<SETTING>**.
2. Highlight [Navigation] and push **<ENTER>**.
3. Highlight [Guidance Settings] and push **<ENTER>**.



4. Highlight [Voice Guidance Settings] and push **<ENTER>**.

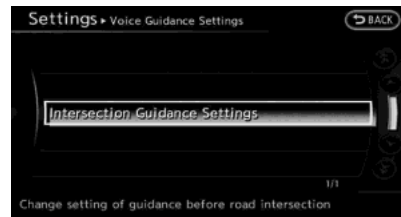

5. Highlight [Intersection Guidance Settings] and push **<ENTER>**.

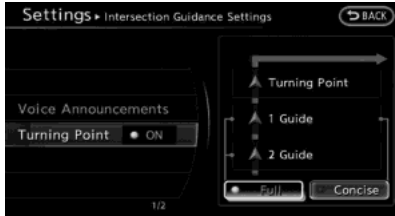

- Highlight the preferred item and push **<ENTER>**.

Available setting items

- [Voice Announcements]: Sets how many times the voice guidance is announced before the vehicle reaches an intersection.
 - Highlight [Voice Announcements] and push **<ENTER>**.
 - Highlight the preferred item and push **<ENTER>**.
 - [Full]: The system announces three kinds of voice guidance: “Turning Point”, “1 Guide” and “2 Guide”.
 - [Concise]: The system announces two kinds of voice guidance: “Turning Point” and “1 Guide”.

- [Turning Point]: Turns on the sound that chimes when a maneuver is supposed to be occurring.

DISPLAYING SMALL TURN ARROW ON MAP

The guidance screen displayed when the vehicle passes through an intersection can be changed.

- Push **<SETTING>**.
- Highlight [Navigation] and push **<ENTER>**.
- Highlight [Guidance Settings] and push **<ENTER>**.



- Highlight [Guidance Display Settings] and push **<ENTER>**.



- Highlight [Small Turn Arrow on Map] and push **<ENTER>** to activate or deactivate Small Turn Arrow on the Map (simplified turn indicator) displayed in the upper left corner of the map screen. The indicator illuminates if the Small Turn Arrow on the Map is displayed.

SWITCHING ESTIMATED ARRIVAL TIME DISPLAY

The display of the travel time on the map screen can be switched between the travel time to the destination and the travel time to the waypoint.

Example: Switching the display to the travel time to the waypoint

- Push **<SETTING>**.
- Highlight [Navigation] and push **<ENTER>**.

5. Route guidance

- Highlight [Guidance Settings] and push **<ENTER>**.



- Highlight [Estimated Time] and push **<ENTER>**.

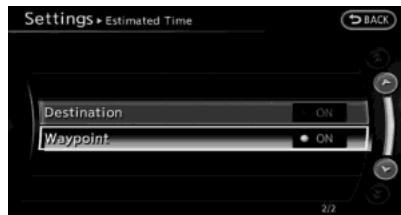

- Highlight [Waypoint] and push **<ENTER>**. The indicator for the selected condition illuminates.
- Push **<MAP>** to return to the current location map screen.

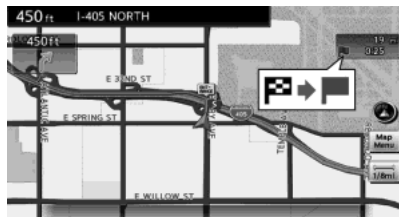

- The icon displayed on the map screen is switched, and the travel time to the waypoint is displayed.

Displayed icon

- : Display of the travel time to the destination
- : Display of the travel time to the waypoint

SET AVERAGE SPEEDS

The required time to the destination can be calculated based on the set vehicle speeds.

Basic operation

- Push **<SETTING>**.
- Highlight [Navigation] and push **<ENTER>**.
- Highlight [Guidance Settings] and push **<ENTER>**.

- Highlight [Others] and push **<ENTER>**.
- Highlight [Set Average Speeds] and push **<ENTER>**.
- Highlight the preferred item and push **<ENTER>**.
- Use the INFINITI controller to make an adjustment. The speed can be increased/decreased by 5 MPH (5 km/h).
- After finishing the setting, push **<ENTER>** or **<BACK>** to activate the setting.
- Push **<BACK>** to return to the previous screen. Push **<MAP>** to return to the current location map screen.

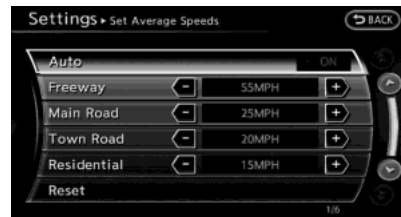

Available setting items

- [Auto]:
If set to ON, the system automatically calculates the required time to the destination, the indicator illuminates and the speed settings cannot be changed.
- [Freeway]:
Adjust the average vehicle speed on a freeway by moving the INFINITI controller in the direction of [+] or [-].
- [Main Road]:
Adjust the average vehicle speed on a main road by moving the INFINITI controller in the direction of [+] or [-].
- [Town Road]:
Adjust the average vehicle speed on a town road by moving the INFINITI controller in the direction of [+] or [-].
- [Residential]:
Adjust the average vehicle speed in a residential area by moving the INFINITI controller in the direction of [+] or [-].
- [Reset]:
Sets the average vehicle speeds to the default values.

5. Route guidance

MEMO

6 Storing location/route

Storing location.....	6-2	Minor adjustment of home or stored address	6-10
Storing location by searching.....	6-2	Editing stored route.....	6-14
Storing current vehicle location.....	6-3	Editing stored tracking	6-15
Storing location by moving map.....	6-4	Editing avoid area	6-16
Storing route.....	6-5	Deleting stored item	6-19
Other settings	6-5	Deleting stored item individually	6-19
Storing tracked route.....	6-6	Deleting individual item on map.....	6-20
Other settings	6-7	Deleting all stored items	6-20
Storing avoid area.....	6-7	Transferring information to/from address book.....	6-22
Editing address book	6-8		
Basic operation.....	6-8		
Editing stored home and address.....	6-9		

6. Storing location/route

STORING LOCATION

Often visited locations can be stored in the Address Book. The stored addresses can be easily retrieved to set them as a destination or waypoint.

INFO:

- The Address Book can store up to 300 locations.
- New information placed in the same storage position will overwrite the old data.

STORING LOCATION BY SEARCHING

After a location is searched for once, it can be stored for future use.

1. Push **<SETTING>**.

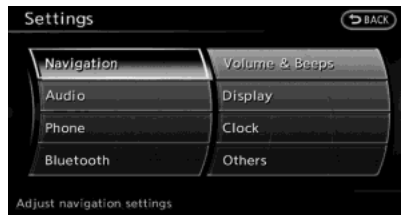

2. Highlight [Navigation] and push **<ENTER>**.

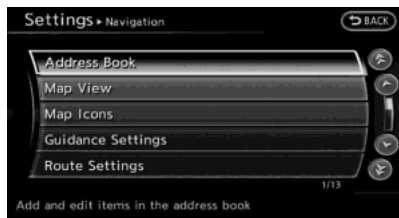

3. Highlight [Address Book] and push **<ENTER>**.

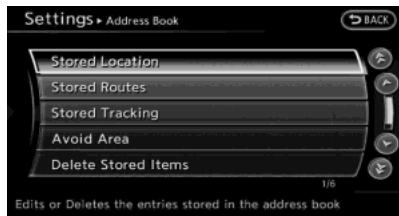

4. Highlight [Stored Location] and push **<ENTER>**.



5. Highlight [Home Location (None)] or [Add New] and push **<ENTER>**.

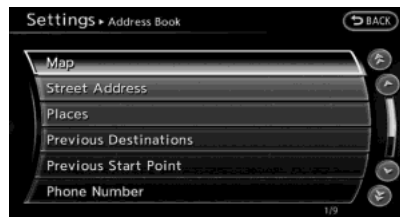

6. Highlight the appropriate method to search for a location and push **<ENTER>**.
 "4. Setting destination"

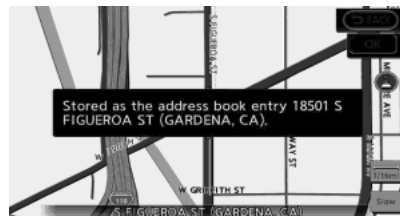

7. When a preferred location is displayed at the center of the map, confirm the address of the location and push **<ENTER>**.

A message is displayed, and the address of the location is stored in the Address Book.

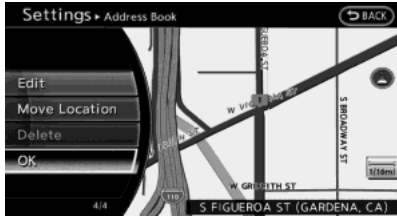

8. Adjust the location of the stored item and edit the contents of the stored item as necessary. After finishing the setting, highlight [OK] and push **<ENTER>**.



INFO:

- When the location is stored in the Address Book, [Address Book] can be used to search for the location.
- A location can be adjusted by selecting [Move Location] using the same method as the one for a destination.

“Moving location of destination”
(page 5-5)

Other settings

An address can also be stored using the following procedure.

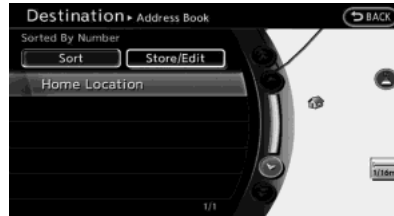

1. Push **<DEST>**.
2. Highlight [Address Book] and push **<ENTER>**.
3. Highlight [Store/Edit] and push **<ENTER>**.
4. Highlight [Add New] and push **<ENTER>**.
5. Highlight the appropriate method to search for a location and push **<ENTER>**. The address of the searched location is stored.
 “4. Setting destination”

STORING CURRENT VEHICLE LOCATION



1. Push **<MAP>** to display the current location map screen.
2. Push **<ENTER>** at the current vehicle location.

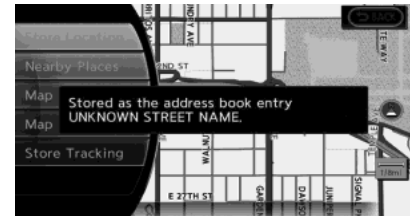

3. Highlight [Store Location] and push **<ENTER>**. A message is displayed, and the current vehicle location is stored in the Address Book.

6. Storing location/route



4. The icon representing the stored location is displayed on the map.

Push **<MAP>** or **<BACK>** to return to the current location map screen.

INFO:

The location is stored in the first available position number in the Address Book list.

STORING LOCATION BY MOVING MAP



1. Move to the preferred location on the map and push **<ENTER>**.

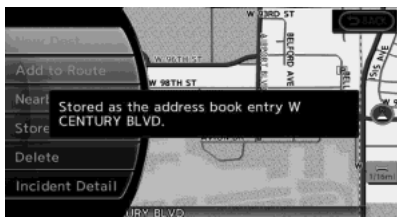

2. Highlight [Store Location] and push **<ENTER>**. A message is displayed, and the address of the location is stored in the Address Book.



3. The icon representing the stored location is displayed on the map.

Push **<MAP>** to return to the current location map screen.

INFO:

The address is stored in the first available position number in the Address Book list.

STORING ROUTE

A maximum of 5 calculated routes can be stored. Stored routes can be easily retrieved and set as the suggested route.



INFO:

Stored route includes only locations (destination and waypoints) and route calculation conditions, not the route itself.

1. Push **<ROUTE>**.



2. Highlight [Route Info] and push **<ENTER>**.



3. Highlight [Store Route] and push **<ENTER>**.

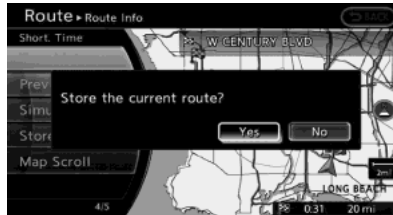

4. A confirmation message is displayed. Confirm the contents of the message, highlight [Yes] and push **<ENTER>**.
The current route is stored.

OTHER SETTINGS

A route can also be stored using the following procedure.

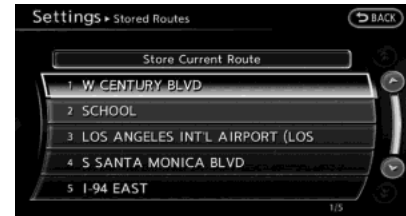

1. Push **<SETTING>**.
2. Highlight [Navigation] and push **<ENTER>**.
3. Highlight [Address Book] and push **<ENTER>**.
4. Highlight [Stored Routes] and push **<ENTER>**.
5. Highlight [Store Current Route] and push **<ENTER>**.
6. A confirmation message is displayed. Confirm the contents of the message, highlight [Yes] and push **<ENTER>**. The current route is stored.

6. Storing location/route

INFO:

- The route is stored in the first available position number in the store current route list.
- A maximum of 5 routes can be stored. When 5 routes are stored in the Address Book, a new route cannot be stored until a route is deleted.
 “Deleting stored item” (page 6-19)
- If any waypoints are not set on the route, the route cannot be stored.

STORING TRACKED ROUTE

A travelled route up to the current location can be stored. A maximum of 5 tracked routes can be stored.



1. Push **<MAP>** to display the current location map screen.
2. Push **<ENTER>** at the current vehicle location.



3. Highlight [Store Tracking] and push **<ENTER>**.

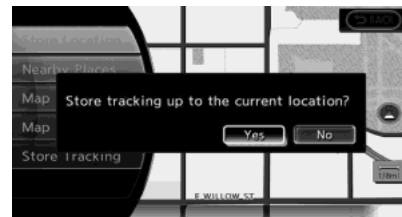

4. A confirmation message is displayed. Confirm the contents of the message, highlight [Yes] and push **<ENTER>**. The tracked route you have traveled is stored.
5. Push **<MAP>** or **<BACK>** to return to the current location map screen.

INFO:

- A maximum of 5 tracked routes can be stored. When 5 tracked routes are stored in the Address Book, a new tracked route cannot be stored until a tracked route is deleted.
 “Deleting stored item” (page 6-19)
- The tracked route is stored in the first available position number in the store tracking list.

OTHER SETTINGS

A tracked route can also be stored using the following procedure.



1. Push **<SETTING>**.
2. Highlight [Navigation] and push **<ENTER>**.
3. Highlight [Address Book] and push **<ENTER>**.
4. Highlight [Stored Tracking] and push **<ENTER>**.
5. Highlight [Add New] and push **<ENTER>**.



INFO:

A tracked route can only be stored using the setting screen when [Current Tracking] is set to on.

STORING AVOID AREA

An Avoid Area can be stored.

The Avoid Area is an area that can be excluded from a route, such as a road that is always congested. Once Avoid Areas are stored, the system avoids those areas when calculating a route. Up to 10 Avoid Areas can be stored.

1. Push **<SETTING>**.

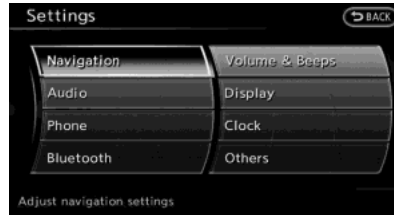

2. Highlight [Navigation] and push **<ENTER>**.

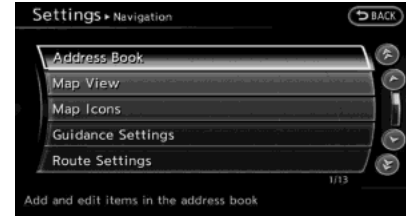

3. Highlight [Address Book] and push **<ENTER>**.

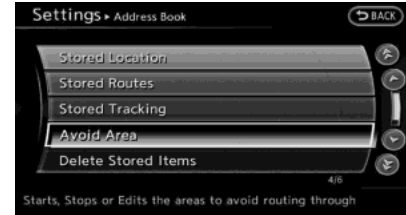

4. Highlight [Avoid Area] and push **<ENTER>**.



6. Storing location/route

- Highlight [Add New] and push **<ENTER>**.

INFO:

A maximum of 10 Avoid Areas can be stored. When 10 Avoid Areas are already stored, a new Avoid Area cannot be stored until a currently stored Avoid Area is deleted.

 “Deleting stored item” (page 6-19)

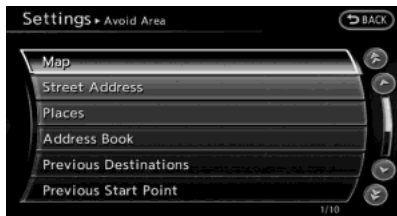





- Highlight the appropriate method to search for a location and push **<ENTER>**.
 “4. Setting destination”



- Set the following items for the searched location.

Available setting items:

- [Rename]:
Changes the name.
 “Rename” (page 6-17)
 - [Move Location]:
Adjusts the location of the Avoid Area.
 “Move Location” (page 6-17)
 - [Resize Area]:
Adjusts the range of the Avoid Area.
 “Resize Area” (page 6-17)
 - [FWY]:
Avoids Freeways.
 “FWY” (page 6-18)
 - [Delete]:
Deletes the avoid area.
 “Delete” (page 6-18)
- After finishing the setting, highlight [OK] and push **<ENTER>**.

EDITING ADDRESS BOOK

Items stored in the Address Book can be modified. These settings can be edited to make the navigation system more useful.

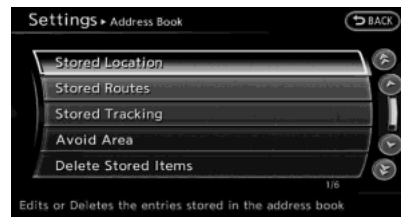

BASIC OPERATION

- Push **<SETTING>**.
- Highlight [Navigation] and push **<ENTER>**.
- Highlight [Address Book] and push **<ENTER>**.
- Highlight the preferred item and push **<ENTER>**.

Available setting items

- [Stored Location]:
Edits the information of a stored home and Address.
☞ “Editing stored home and address” (page 6-9)
- [Stored Routes]:
Edits the information of a stored route.
☞ “Editing stored route” (page 6-14)
- [Stored Tracking]:
Edits the information of a stored tracked route.
☞ “Editing stored tracking” (page 6-15)
- [Avoid Area]:
Edits the information of a stored Avoid Area.
☞ “Editing avoid area” (page 6-16)
- [Delete Stored Items]:
Deletes a stored location or route.
☞ “Deleting all stored items” (page 6-20)
- [Transfer Address Book]:
Imports or exports the data of the stored items using a USB memory.

EDITING STORED HOME AND ADDRESS



1. Highlight [Stored Location] and push **<ENTER>**.
2. Highlight the stored home location or preferred stored address and push **<ENTER>**.



INFO:

Highlighting [Sort] displays a list of various sort functions.
To use the sort functions, stored locations must be set in advance.
☞ “Minor adjustment of home or stored address” (page 6-10)

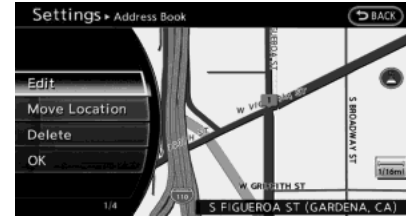

3. Highlight the preferred item and push **<ENTER>**.

Available setting items

- [Edit]:
Edits the stored address information.
- [Move Location]:
Adjusts the location of the stored address.
- [Delete]:
Deletes the stored address.
- [OK]:
Applies the settings.

Other settings

A stored address can also be edited using the following procedure.

6. Storing location/route

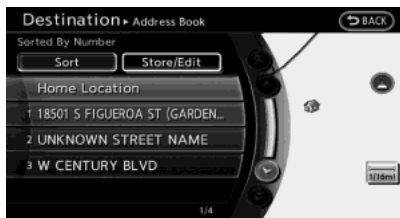

1. Push **<DEST>**.
2. Highlight [Address Book] and push **<ENTER>**.
3. Highlight [Store/Edit] and push **<ENTER>**.

MINOR ADJUSTMENT OF HOME OR STORED ADDRESS

When [Edit] is selected, you can edit the following items of the home or stored location can be edited.

- [Show Icon on Map]
- [Name] (only for stored locations)
- [Voicetag] (only for stored locations)
- [Icon]
- [Sound]
- [Direction]

- [Distance]
- [Phone No.]
- [Group] (only for stored locations)
- [Entry Numbers] (only for stored locations)

Show Icon on Map

Displays the home icon or the stored address icon on the map.

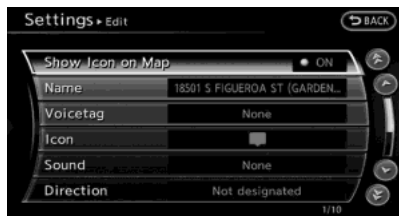

1. Highlight [Show Icon on Map] and push **<ENTER>**.
2. The indicator illuminates when the item is set. Then the system displays the icon on the map.

Name (only for stored locations)

Changes the name of a stored location.

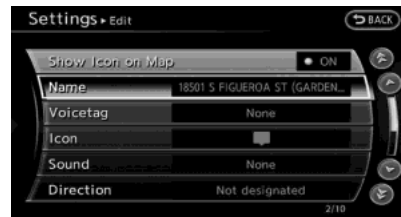

1. Highlight [Name] and push **<ENTER>**.
A character input screen is displayed.



2. Enter the preferred name for the stored location.
☞ “How to input letters and numbers” (page 2-16)
3. Highlight [OK] and push **<ENTER>**.
The name is stored.

Voicetag (only for stored locations)

Stores the voicetag for the stored location. The voicetag allows you to set the stored location as a destination using Voice Recognition.



1. Highlight [Voicetag] and push **<ENTER>**.

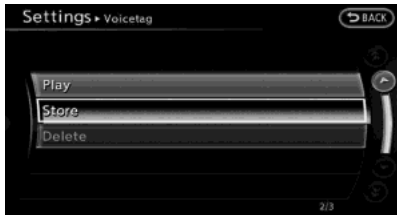

2. Highlight [Store] and push **<ENTER>**.

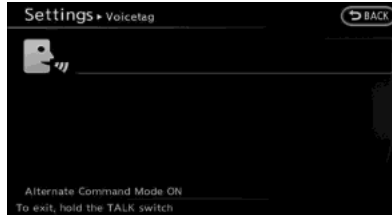

3. A beep sounds, and the system enters the voice command reception mode.
4. Speak the name/word to be used as Voicetag.
5. The Voicetag is stored, provided the system recognizes it.

INFO:

- A Voicetag cannot be stored, overwritten or played while driving.
- The Address Book can store up to 100 Voicetags.
- Highlight [Play] to confirm the stored Voicetag.
- Highlight [Delete] to delete a stored Voicetag.
- If a Voicetag is already stored, select [Restore] to re-record the Voicetag.

Icon

Changes the icon of the home or stored address to the preferred one. By changing the icons, the usage of the [By Icon] option of the sort function can be optimized more effectively.

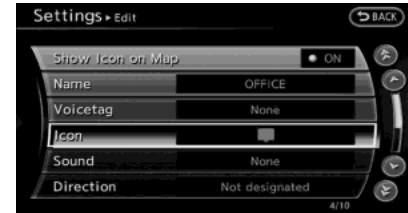

1. Highlight [Icon] and push **<ENTER>**.

A list of icons is displayed.



2. Highlight the preferred icon and push **<ENTER>**.

The icon is changed.

6. Storing location/route

Sound

Sets the tone of the alarm that sounds when the vehicle approaches the home or a stored address.

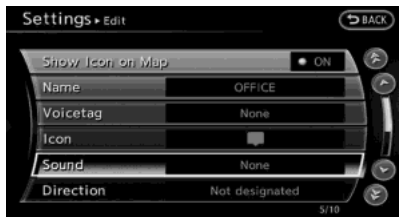

1. Highlight [Sound] and push **<ENTER>**.
A sound list is displayed.

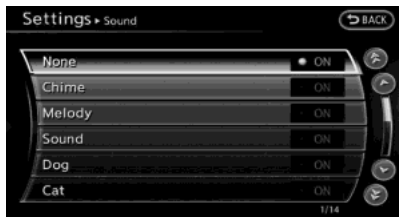

2. Select the preferred alarm tone and push **<ENTER>**.
The indicator of the selected alarm tone illuminates.

Sound list:

None
Chime
Melody
Sound
Dog
Cat
Wave
Church bell
Marimba
Trumpet
Horn
Scratch

Direction

Sets the alarm to sound when approaching from a specific direction.

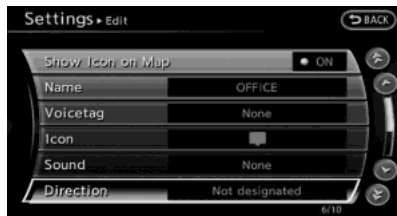

1. Highlight [Direction] and push **<ENTER>**.

A map screen with the home or stored location located on the map center is displayed.

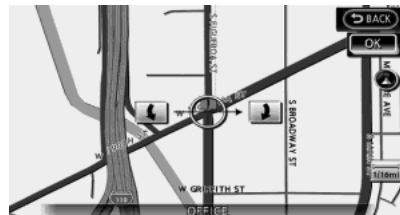

2. Set the direction that sounds the alarm and push **<ENTER>**.
The selected direction is set.



INFO:

After the direction is set and [Direction] is selected and set again, a confirmation message is displayed. Confirm the contents of the message, highlight [Yes] and push **<ENTER>**. The set direction is overwritten.

Distance

Sets the alarm to sound when reaching a specific distance to the home or stored address.

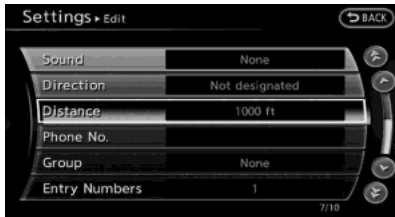

1. Highlight [Distance] and push **<ENTER>**.

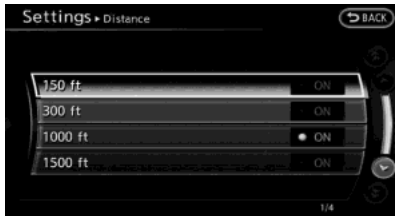

2. Highlight the preferred distance option and push **<ENTER>**. The indicator of the selected distance illuminates.

Available distance options:

- 150 feet (50 m)
- 300 feet (100 m)
- 1000 feet (300 m)
- 1500 feet (500 m)

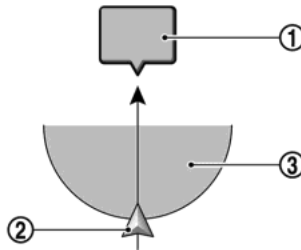

INFO:

Once the direction and the distance to sound an alarm are set, the system will sound the alarm when the vehicle enters the triggering zone.

- ① Stored location icon
- ② Vehicle icon
- ③ Trigger zone

Phone number

Stores the telephone number of the home or a stored location.

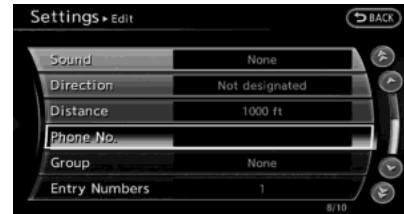

1. Highlight [Phone No.] and push **<ENTER>**. The telephone number entry screen is displayed.



2. Enter the telephone number of the home or stored location.
 "Number input screen"
 (page 2-17)

6. Storing location/route

1. Highlight [OK] and push **<ENTER>**. The telephone number is stored.



INFO:

If the phone number of the home or a location is stored, the phone number can be used to search for the destination even if it is not included in the map data.

Group (only for stored locations)

This groups the stored locations.

By grouping the stored locations, the [By Group] option of the sort function can be used more effectively in the [Sort Entries] mode.

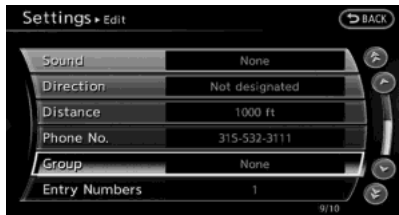

1. Highlight [Group] and push **<ENTER>**.

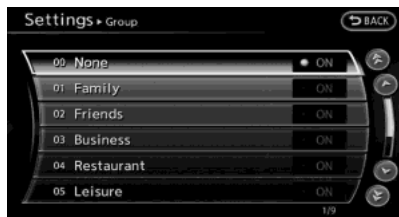

2. Highlight the preferred group and push **<ENTER>**.

When the indicator of the selected group illuminates, the stored location is classified into the applicable group.

Entry Numbers (only for stored locations)

Switches the entry numbers of any two stored locations in the list.

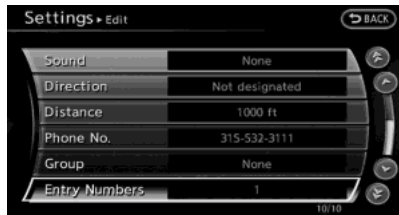

1. Highlight [Entry Numbers] and push **<ENTER>**.

A list of stored locations is displayed.



2. Highlight the stored addresses that you want to change and push **<ENTER>**.

The position numbers of the selected stored locations are changed.

EDITING STORED ROUTE

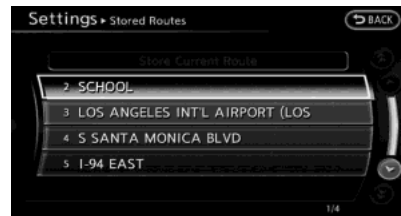

1. Highlight [Stored Routes] and push **<ENTER>**.
2. Highlight the preferred stored route and push **<ENTER>**.



3. Highlight the preferred item to edit from the list on the right side of the screen and push **<ENTER>**.
4. After finishing the editing, highlight [OK] and push **<ENTER>**.



INFO:

If [Store Current Route] is selected, the system stores the current route.

Available setting items

- [Rename]:
Changes the name.
 "Character (letters and numbers) input screen" (page 2-16)

- [Replace]:
Overwrites the stored route with the current route.
- [Delete]:
Deletes the stored route.
- [OK]:
Applies the settings.

EDITING STORED TRACKING



1. Highlight [Stored Tracking] and push **<ENTER>**.
2. Highlight the stored tracked route and push **<ENTER>**. When the "ON" indicator is not illuminated, push **<ENTER>**. The indicator illuminates, and the Edit screen is displayed.

If **<ENTER>** is pushed while the "ON" indicator is illuminated, the indicator turns off.



3. Highlight the preferred item and push **<ENTER>**.
- ### Available setting items (Current tracking)

- [View Track]:
Displays the tracked route up to the current location.
- [Delete]:
Deletes the stored current tracking.
- [OK]:
Applies the settings.



6. Storing location/route

Available setting items (Stored tracked routes)

- [View Track]:
Displays a stored tracked route on the map.
- [Rename]:
Changes the name.
 “Character (letters and numbers) input screen” (page 2-16)
- [Replace]:
Overwrites the stored tracked route with the current tracked route.
- [Delete]:
Deletes the stored tracked route.
- [OK]:
Applies the settings.

Displaying a tracked route

The stored tracked route can be displayed on the map as necessary.



1. Highlight [Stored Tracking] and push **<ENTER>**.
2. Highlight a tracked route to display on the map screen, and push **<ENTER>**. The “ON” indicator illuminates, and the Edit screen is displayed.



3. After confirming the location to display the tracked route, highlight [OK] and push **<ENTER>**. The screen returns to the previous screen.

4. Push **<MAP>** to return to the current location map screen.

INFO:

- Current tracking is displayed up to 6 miles (10 km).
- Stored tracking is displayed up to 12 miles (20 km).

EDITING AVOID AREA



1. Highlight [Avoid Area] and push **<ENTER>**.
2. Highlight the preferred Avoid Area and push **<ENTER>**.

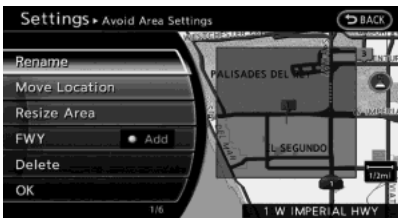

3. Highlight the preferred items and push **<ENTER>**.

Available setting items

- [Rename]:
Changes the name.
- [Move Location]:
Adjusts the location of the Avoid Area.
- [Resize Area]:
Adjusts the range of the Avoid Area.
- [FWY]:
Avoids freeways.
- [Delete]:
Deletes the Avoid Area.
- [OK]:
Applies the setting.

4. After finishing the setting, highlight [OK] and push **<ENTER>**.

INFO:

An Avoid Area can be added by selecting [Add New].

☞ “Storing avoid area” (page 6-7)

Rename

Changes the name of an Avoid Area.



1. Highlight [Rename] and push **<ENTER>**. A character input screen is displayed.
2. Enter the preferred name for the avoid area.
3. Highlight [OK] and push **<ENTER>**. The name is stored.

Move Location

Adjusts the location of the Avoid Area.



1. Highlight [Move Location] and push **<ENTER>**.
2. Adjust the location of the Avoid Area.
3. After adjusting the location, push **<ENTER>**.

Resize Area

Adjusts the range of the Avoid Area.

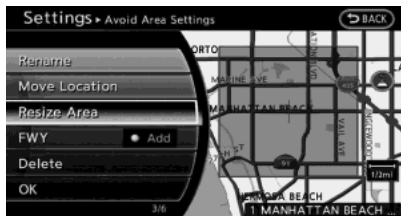

6. Storing location/route

1. Highlight [Resize Area] and push **<ENTER>**.
2. Highlight the range from 5 available levels.
3. After highlighting the range, push **<ENTER>**.



INFO:

Turning the center dial to change the scale of the map.

Push **<ZOOM IN>/<ZOOM OUT>** (if so equipped) to change the scale of the map.

FWY

Sets the route to avoid freeways.

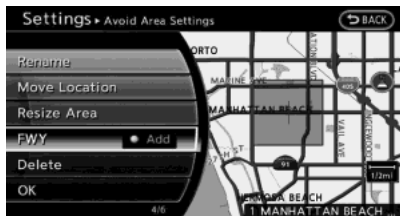

1. Highlight [FWY].
To include freeways in the Avoid Area, push **<ENTER>** to illuminate this indicator.

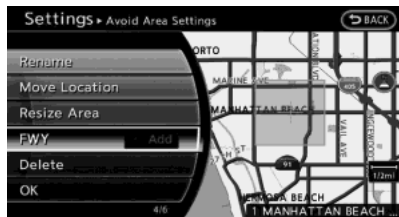

2. The Avoid Area is displayed in green if it includes a freeway or in blue if it does not include a freeway.



INFO:

If the current vehicle location is set to an Avoid Area, the system will not provide route guidance.

Delete

Deletes the Avoid Area.

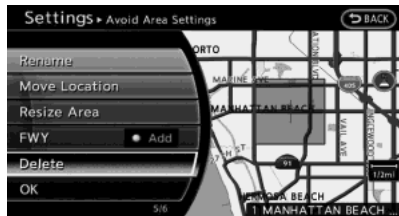

1. Highlight [Delete] and push **<ENTER>**.



2. A confirmation message is displayed. Confirm the contents of the message, highlight [Yes] and push **<ENTER>**. The stored item is deleted from the Address Book.

DELETING STORED ITEM

The locations and routes in the Address Book can be deleted. Two deletion methods are available: deleting an individual item and deleting all stored items.

! NOTE:

Deleted items cannot be restored. Before deleting an item, always make sure that the item is truly not necessary.

DELETING STORED ITEM INDIVIDUALLY

You can delete stored addresses, routes, tracking and avoid areas individually.

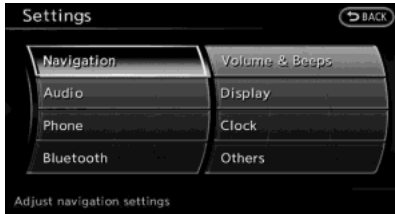

1. Push **<SETTING>**.
2. Highlight [Navigation] and push **<ENTER>**.

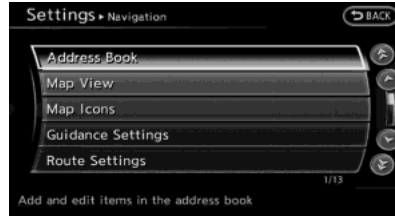

3. Highlight [Address Book] and push **<ENTER>**.

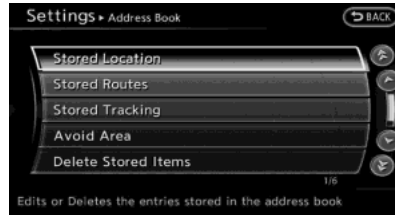

Example: [Stored Location] is highlighted.

4. Highlight the preferred item for deletion and push **<ENTER>**.



5. Highlight the preferred location/route for deletion and push **<ENTER>**.

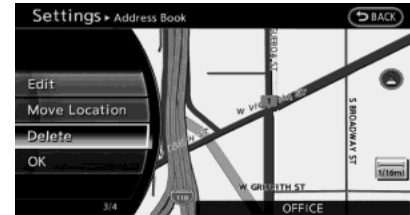

6. Highlight [Delete] and push **<ENTER>**.

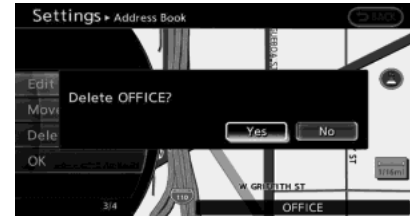

6. Storing location/route

1. A confirmation message is displayed. Confirm the contents of the message, highlight [Yes] and push **<ENTER>**. The stored item is deleted from the Address Book.

Other settings

A stored address can also be deleted using the following procedure.



1. Push **<DEST>**.
2. Highlight [Address Book] and push **<ENTER>**.
3. Highlight [Store/Edit] and push **<ENTER>**.
4. Highlight [Edit or Delete an Entry] and push **<ENTER>**.
5. Highlight a preferred address and push **<ENTER>**.
☞ "4. Setting destination"

INFO:

This procedure applies only for deleting a stored home or address. A stored route, tracking or avoid area cannot be deleted using this procedure.

DELETING INDIVIDUAL ITEM ON MAP

1. Align the cross pointer over the preferred stored location for deletion by moving on the map. Then push **<ENTER>**.



2. Highlight [Delete] and push **<ENTER>**.

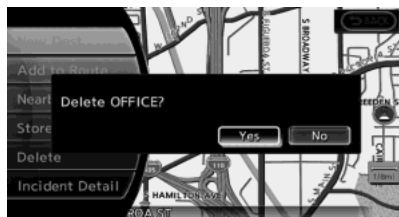

3. A confirmation message is displayed. Confirm the contents of the message, highlight [Yes] and push **<ENTER>**. The stored item is deleted from the Address Book.

DELETING ALL STORED ITEMS

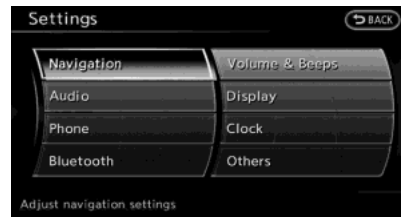

1. Push **<SETTING>**.
2. Highlight [Navigation] and push **<ENTER>**.

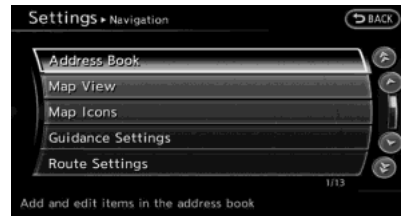

3. Highlight [Address Book] and push **<ENTER>**.

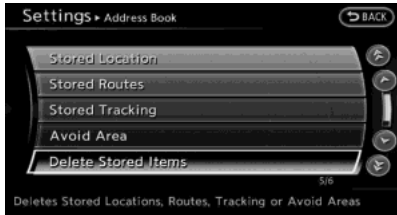

4. Highlight [Delete Stored Items] and push **<ENTER>**.



5. Highlight the preferred item for deletion and push **<ENTER>**

Items that can be deleted

- [Delete Home Location]:
Deletes the home location.

- [Delete Address Book]:
Deletes all stored locations.
- [Delete Stored Routes]:
Deletes all stored routes.
- [Delete Current Tracking]:
Deletes the current tracked route.
- [Delete Stored Tracking]:
Deletes all stored tracked routes.
- [Delete Avoid Areas]:
Deletes all stored Avoid Areas.
- [Delete Stored Voicetags]:
Deletes all stored Voicetags.
- [Delete Connected Search History] (if so equipped):
Delete all search history of Connected Search.
- [Delete Previous Destinations]:
Deletes all or one of the previous destinations.
- [Delete Previous Start Point]:
Deletes all previous start points.
- [Delete Learned Route]:
Deletes all system learned routes.



6. A confirmation message is displayed. Confirm the contents of the message, highlight [Yes] and push **<ENTER>**. The stored items are deleted from the Address Book.



INFO:

[Delete Connected Search History] is the feature of Infiniti Connection™. A subscription is necessary to receive Infiniti Connection services.

Other settings

All stored addresses can also be deleted using the following procedure.

6. Storing location/route



1. Push **<DEST>**.
2. Highlight [Address Book] and push **<ENTER>**.
3. Highlight [Store/Edit] and push **<ENTER>**.
4. Highlight [Delete All Addressbook Entries] and push **<ENTER>**.
☞ "4. Setting destination"

INFO:

This procedure applies only for deleting a stored home or address. A stored route, tracking or avoid area cannot be deleted using this procedure.

TRANSFERRING INFORMATION TO/FROM ADDRESS BOOK

The information of the stored home and addresses can be exported and imported using a USB memory device.

INFO:

A USB memory can be used to transfer data but it is not possible to edit data using a personal computer, etc.

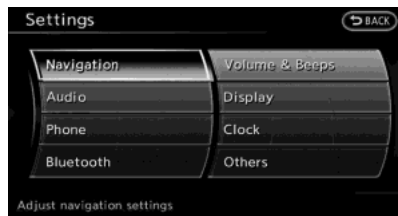

1. Insert a USB memory device and push **<SETTING>**.

INFO:

2. Highlight [Navigation] and push **<ENTER>**.

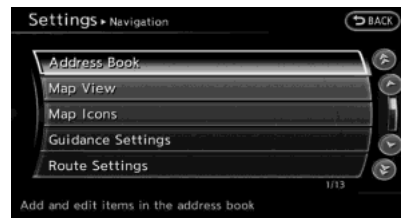

3. Highlight [Address Book] and push **<ENTER>**.

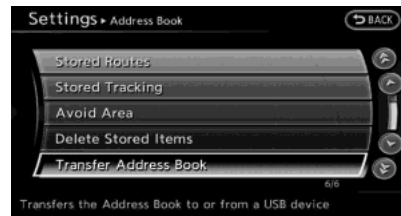

4. Highlight [Transfer Address Book] and push **<ENTER>**.

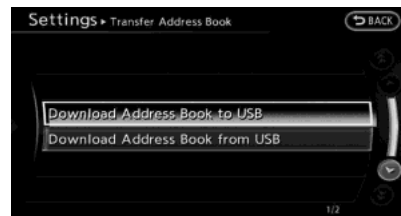

5. Highlight [Download Address Book to USB] or [Download Address Book from USB] and push **<ENTER>**.

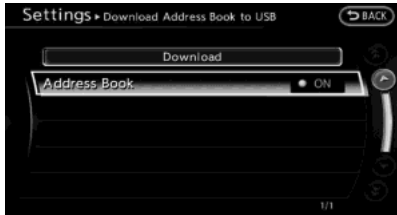

6. Highlight a stored item. The [ON] indicator illuminates.

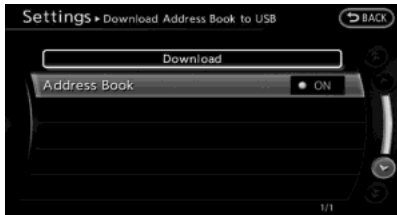

7. Highlight [Download] and push **<ENTER>**.

! **NOTE:**

Do not remove the USB memory until the system completely imports or exports the data.



i **INFO:**

If the USB memory already has the data for a stored address, a confirmation message is displayed. Once overwritten, the original data cannot be recovered.

6. Storing location/route

MEMO

7 Viewing technical information

Information screen	7-2	Viewing available traffic information	7-16
Basic operation.....	7-2	Basic operation	7-17
Infiniti Connection™ (if so equipped)	7-3	Info on route	7-17
Legal disclaimer.....	7-3	Nearby traffic Info.....	7-17
Infiniti Connection features	7-3	Display urgent traffic information	7-18
Basic operation.....	7-8	Traffic information on map.....	7-19
Viewing information feeds.....	7-9	Traffic information settings.....	7-20
Updating All Information Feeds	7-10	Viewing available weather information.....	7-22
Connecting to Interactive Voice Menu.....	7-11	Displaying weather information screen	7-23
Viewing information feeds history	7-12	Destination weather on suggested	
Deleting Infiniti Connection history.....	7-12	route screen	7-28
Initializing all Infiniti Connection settings.....	7-13	Automatically display warnings/watches	7-29
Displaying unit ID information.....	7-13	Map update	7-31
Volume setting.....	7-14	Viewing navigation system unit identification....	7-32
Emergency support	7-14	Basic operation	7-32
Viewing information about current		Viewing navigation system	
vehicle location	7-15	version information.....	7-32
Basic operation.....	7-15	Basic operation	7-32
		Viewing GPS current location information	7-32
		Basic operation	7-32

7. Viewing technical information

INFORMATION SCREEN

This screen sets or displays various information that is helpful for using the vehicle safely and comfortably.

Available items include the vehicle information, Infiniti Connection™ (if so equipped), Traffic Info. setup, current location information, GPS information, Voice recognition list and map version.



INFO:

- A NavTraffic subscription is necessary to view Traffic Info.
- [Infiniti Connection] is a feature of Infiniti Connection. Use of this feature is dependent upon a valid subscription and the telematics device being in operative condition, as well as cellular connectivity, navigation map data and GPS satellite signal reception being available.





BASIC OPERATION

1. Push **<INFO>**.
2. Highlight the preferred item and push **<ENTER>**.

Available items

- [Infiniti Connection] (if so equipped): Displays various types of information or receives services by connecting your vehicle to the Infiniti Connection Data Center.
☞ “Infiniti Connection™” (page 7-3)
- [Energy Flow] (if so equipped): Refer to the vehicle Owner’s Manual.
- [Fuel Economy]: Refer to the vehicle Owner’s Manual.
- [Tire Pressure] (if so equipped): Refer to the vehicle Owner’s Manual.

- [Maintenance]: Refer to the vehicle Owner’s Manual.
- [Traffic Info]: Allows Traffic Info. setup.
☞ “Viewing available traffic information” (page 7-16)
- [Weather Info]: Displays weather information.
☞ “Viewing available weather information” (page 7-22)
- [Trip Computer] (if so equipped): Refer to the vehicle Owner’s Manual.
- [Others]:
 - [Where am I?]: Displays information regarding the current vehicle location.
☞ “Viewing information about current vehicle location” (page 7-15)
 - [Map Update]: Displays the map version and enables updating of the map data.
☞ “Map update” (page 7-31)
 - [Navigation Version]: Displays the current navigation system version.
☞ “Viewing navigation system version information” (page 7-32)

- [GPS Position]:
Displays GPS information regarding the current vehicle location.
 "Viewing GPS current location information" (page 7-32)
- [Voice Recognition]:
Displays information on how to use the voice recognition.
 "9. Voice recognition"



INFO:

The displayed items vary depending on the options that are equipped on the vehicle.

INFINITI CONNECTION™ (if so equipped)

LEGAL DISCLAIMER

Avoid operating Infiniti Connection™ and Infiniti Connection Plus services in such a way that you are distracted while driving. Infiniti Connection Subscription Agreement required to enroll.

Beginning on your date of purchase, for a period of time, services are complimentary. At the expiration of the complimentary period, your credit card (if on file) will be charged and your service will automatically renew in accordance with the terms of your Infiniti Connection Subscription Agreement.

Services are dependent upon subscription enrollment and the telematics device being in operative condition, cellular connection availability, navigation map data, and GPS satellite signal reception, which can limit the ability to reach Infiniti Connection or to receive support. Requires compatible GSM/GPRS cellular network. Should the cellular provider terminate or restrict network service, services will not be available. Under this circumstance, your service may be suspended or terminated without notice

and without liability to Nissan, Nissan's third party service providers, the underlying wireless carrier or any third party beneficiary. In the event a change of telecommunications systems or services becomes necessary, you are solely responsible for replacing, as well as the cost of replacing, any equipment in the vehicle that is necessitated. Terms and conditions of Infiniti Connection Subscription Agreement apply.

INFINITI CONNECTION FEATURES

Infiniti Connection provides various types of information and services by connecting your vehicle to the Infiniti Connection Data Center and Infiniti Connection Response Center using TCU (Telematics Communication Unit) installed in your vehicle.



WARNING

- **Radio waves could adversely affect electric medical equipment. Those who use a pacemaker should contact the electric medical equipment manufacturer regarding the possible influences before use.**
- **The TCU antenna is installed inside the upper central part of the instrument panel. An occupant should not get any**

7. Viewing technical information

closer to the antenna than specified by the pacemaker manufacturer. The radio waves from the TCU antenna may adversely affect the operation of the pacemaker while using the Infiniti Connection service.

- Please note that the Automatic Collision Notification service and Emergency Call function cannot be used in the following conditions:
 - The vehicle moves outside the service area where the TCU (Telematics Communication Unit) is connected to Infiniti Connection.
 - The vehicle is in a location with poor signal reception such as a tunnel, underground parking, behind a building or in a mountainous area.
 - It may not be possible to make an emergency call in all accidents or emergencies, or if you are in a location without reception.



INFO:

- Infiniti Connection features are dependent upon subscription enrollment and the telematics device being in operative condition, cellular connectivity, navigation map data and GPS satellite signal reception. Terms and conditions of Infiniti Connection Subscription Agreement apply.
- Enrollment is required in order to receive Infiniti Connection services. The services that can be received vary depending on the plan in which you are enrolled.
- All services can be used free of charge for the first year of ownership.
- After the first year, use of the service will no longer be free of charge. The services that can be received vary depending on the plan to which you subscribe.
- Laws in some jurisdictions may restrict the use of “Text-to-Speech.” Check local regulations before using this feature.

Infiniti Connection services may be updated. The latest detailed information is available on the following websites or support line.

Infiniti Connection website:

www.infiniticonnection.com (for U.S.)
<https://canada.infiniticonnection.com>
(for Canada)

Infiniti Connection support line:
1-800-334-7858 (for U.S.)
1-855-892-7418 (for Canada)

● Automatic Collision Notification:

TCU (Telematics Communication Unit) generates a signal automatically to the Infiniti Connection Response Center in the case of an accident severe enough to trigger one of the vehicle’s airbags. Upon the signal, a Response Specialist receives the vehicle location and customer information and notifies the proper authorities in accordance with established policies and procedures.

● Emergency Call:

Emergency Call feature provides emergency assistance by connecting to an Response Specialist in case of an emergency by pushing the in∅vehicle **<SOS>** button. The Response Specialist can help provide various types of assistance depending on the situation.
 “Emergency support” (page 7-14)

- **Enhanced Roadside Assistance:**

Enhanced Roadside Assistance allows you to receive assistance from the Roadside Response Specialist for a non-emergency incident that requires a towing or third party response service. The service is accessed by touching the IVR (Interactive Voice Response) soft button on the navigation screen or by pushing the in-vehicle <SOS> button. Roadside Assistance may also be used in conjunction with the Emergency Assistance service, if warranted.

 "Emergency support" (page 7-14)

- **My Schedule:**

My Schedule feature allows accessing to your personal online Google Calendar™ via the navigation system and displaying the calendar or read out the schedule. This service will also allow you to review your appointments and meetings, and select the meeting location as a destination.

 "Viewing information feeds"
(page 7-9)

- **Report Stolen Vehicle:**

A Response Specialist will attempt to obtain location information from a

reported stolen vehicle and provide that information to local law enforcement agencies to assist in the recovery of your stolen vehicle.

- **Remote Door Lock/Unlock:**

Remote Door Lock/Unlock feature allows you to access the vehicle remotely by calling to an Infiniti Connection Response Specialist or from the Infiniti Connection website to send lock or unlock commands to the vehicle.

 "Connecting to Interactive Voice Menu" (page 7-11)

- **Alarm Notification:**

Alarm Notification feature will notify you via the chosen notification method in the Infiniti Connection website when your vehicle alarm system is activated.

- **Scheduled Maintenance Notification:**

The Maintenance Alert Notification provides vehicle's mileage data to INFINITI. INFINITI notifies you of the maintenance notifications using this mileage data.

- **Maintenance Alert:**

Maintenance Alert allows you to receive notifications via the chosen notification method set in the Infiniti Connection

website in the case of a vehicle subsystem malfunction. The service is managed through the Infiniti Connection website.

- **Destination Assistance:**

Destination Assistance helps you to search a destination via the Interactive Voice Response (IVR) system or a live Response Specialist by pushing the IVR soft button on the navigation screen. The IVR system will ask you for name, item or address, etc. to locate your requested point of interest and accesses a third-party service to bring up the most applicable results. A Response Specialist will ask you if your request is not recognized in the IVR session.

- **Destination Send-to-Vehicle:**

Destination Send-to-Vehicle feature allows you to find the point of interest information from the latest database within the Infiniti Connection website and download to the vehicle.

- **Connected Search:**

Connected Search gives you the ability to conduct a point of interest search around the vehicle location via the

7. Viewing technical information

Destination menu of the navigation system. This search links to the Infiniti Connection database which may have destination information more up-to-date than your Infiniti hard-drive navigation system.

 "Setting by Infiniti Connection™" (page 4-14)

- **Drive Zone:**

Drive Zone feature allows you to monitor the movement of your vehicle in and out of specified regions. Using the Infiniti Connection website or the Interactive Voice Response (IVR), you can define a series of allowed or restricted regions, and are then alerted via your chosen notification method when the vehicle enters or leaves a designated region. You can also query the Infiniti Connection website to see a listing of alert notifications received.

- **Max Speed Alert:**

Max Speed Alert allows you to monitor the speed of your vehicle by receiving alerts. You can set the maximum speed via the Infiniti Connection website, and if your vehicle exceeds the specified speed threshold, you will receive a notification via the chosen method.

You can also query the Infiniti Connection website to view a listing of Max Speed Alert notifications.

- **Mobile Information Service (if so equipped):**

Mobile Information Service (MIS) delivers information such as the latest news headlines, stock quotes and sports scores set in the Infiniti Connection website to be displayed on your navigation screen or be read out.

 "Viewing information feeds" (page 7-9)

- **Infiniti Personal Assistant:**

Infiniti Personal Assistant delivers a high-quality assistant-like service by providing a quick-assist program designed to provide immediate information or assistance. Services and features are driver-centric and enable you to make restaurant, hotel or airline reservations, purchase movie, theater or sporting event tickets, and receive local information based on your requests.

 "Connecting to Interactive Voice Menu" (page 7-11)

- **Valet Alert:**

Valet Alert notifies you if the vehicle moves outside a 0.2 mile radius of the location set on the Infiniti Connection website. You can activate Valet Alert from the "Voice Menu" and saying "Valet Alert" when the call is connected.

 "Connecting to Interactive Voice Menu" (page 7-11)

Notice to Bluetooth® Hands-free phone users

The Bluetooth® Hands-free phone system will be disabled and not be able to take phone calls while the vehicle is connected to the Infiniti Connection Response Specialists or the emergency support staff at the Infiniti Response Center. This is to avoid various services by Infiniti Connection Response Specialists (such as route guidance) and Infiniti Connection emergency support staff being interrupted by incoming calls. Incoming phone calls received while the vehicle is connected to the Service Center will not be listed in the call history of the Bluetooth® Hands-free phone system. However those incoming calls may be listed in the call history of

your mobile phone, depending on its capabilities. After disconnecting communication with the Infiniti Connection Response Specialist or Infiniti Connection emergency support staff, check the incoming call history on your mobile phone when it is safe to do so.

Service application

A separately purchased Infiniti Connection subscription is required. For detailed information, contact an INFINITI retailer or refer to the following Infiniti Connection website:

www.infiniticonnection.com (for U.S.)

<https://canada.infiniticonnection.com> (for Canada)



INFO:

If the vehicle is owned by another person and is resold, the subscription for this service must be canceled and all data stored on the device must be deleted.

Operating tips



WARNING

- **Laws in some jurisdictions may restrict the use of some of the applications and features, such as social networking and texting. Check local regulations for any requirements.**
 - **Laws in some jurisdictions may restrict the use of “Text-to-Speech.” Check local regulations before using this feature.**
 - **Use the Infiniti Connection services after stopping your vehicle in a safe location. If you have to use the Infiniti Connection services while driving, exercise extreme caution at all times so full attention may be given to vehicle operation.**
 - **If you are unable to devote full attention to vehicle operation while talking with the Infiniti Connection services, pull off the road to a safe location and stop your vehicle.**
 - Do not use the Infiniti Connection service with the engine or the hybrid system stopped. Doing so may discharge the vehicle battery.
- The Infiniti Connection services cannot be used under the following conditions:
 - Infiniti Connection subscription has expired.
 - The vehicle is outside the area where the cellular network service is receivable.
 - The vehicle is in a location with poor signal reception such as tunnels, underground parking garages, behind buildings or in mountainous areas.
 - The line is busy.
 - The TCU (Telematics Communication Unit) or other systems of your vehicle are not working properly.
 - The Infiniti Connection services network system is disabled.
 - Information Feeds download cannot be used when the vehicle is connected to the Infiniti Connection Data Center and Infiniti Connection Response Center.
 - Communication with the Infiniti Connection Data Center is related to the data communication mode and may cause occasional difficulty in receiving signals, and the signal receivable area may be limited compared to regular mobile phones.

7. Viewing technical information

- You may hear clicks or experience interruptions while speaking with the Infiniti Connection Response Specialists. This is due to a shift in the connection zone and is not a malfunction.
- Depending on the line used, the sound volume may decrease. Adjust the volume as necessary.
- Received sounds may be distorted or ambient noise may sound like voices of a crowd. This is due to the use of the digital line and is not a malfunction.
- You may hear your own voice from the speaker when talking with the Infiniti Connection Response Specialists due to a network disturbance. When this occurs, reconnect the line after a few minutes or at a different location.
- This vehicle incorporates a communication device that is called a TCU (Telematics Communication Unit). The communication connection between this unit and the Infiniti Connection Data Center allows for various services. When the system connects to the Infiniti Connection Data Center, an antenna icon will appear on the screen.

Use the service in a location where the symbol representing good signal reception appears on the screen.



: When the signal reception is good



: When the signal reception is bad

- The Infiniti Connection service uses the TCU (Telematics Communication Unit). Even if the signal strength bar of the in-vehicle data communication module indicates good reception, connection to the Infiniti Connection Data Center may be disabled. This does not indicate a malfunction. Operate the system again after a few minutes.

BASIC OPERATION

With the Infiniti Connection service, various information can be received and displayed on the screen. The information can also be announced by the system.

1. Push **<INFO>**.



2. Highlight [Infiniti Connection] and push **<ENTER>**.



3. Highlight the preferred item and push **<ENTER>**.

Available items

- [All Information Feeds]: Displays a list of available information feeds.
 “Viewing information feeds” (page 7-9)

7. Viewing technical information

- [Connect to Voice Menu]:
Connects to the Infiniti Connection Interactive Voice Menu.
☞ “Connecting to Interactive Voice Menu” (page 7-11)
- [History]:
Displays a list of Infiniti Connection information that has been used.
☞ “Viewing information feeds history” (page 7-12)
- [Sync All Information Feeds]:
Updates the All Information Feeds list.
☞ “Updating All Information Feeds” (page 7-10)

VIEWING INFORMATION FEEDS

Contents of the various Infiniti Connection information services can be downloaded.

Downloading information feeds

1. Push **<INFO>**.
2. Highlight [Infiniti Connection] and push **<ENTER>**.



3. Highlight [All Information Feeds] and push **<ENTER>**. A list screen is displayed.



4. Highlight the preferred information feeds and push **<ENTER>**. An information feeds list is displayed. The content is announced by the system (Text-to-Speech) while the vehicle is being driven, or if parked, you can read the content on the display.



INFO:

- Touch [Stop] during communication with the Infiniti Connection Data Center to cancel the connection.
- A message is displayed when the communication is disconnected while downloading information due to a poor communication status. Select [Yes] to restart the download.
- Laws in some jurisdictions may restrict the use of “Text-to-Speech.” Check local regulations before using this feature.
- Some terminology such as personal names, place names, special terms, symbols, etc. may not be announced correctly. This is not a malfunction.
- The system will pause announcements when interrupted by the voice guidance given by the navigation system. When the voice guidance finishes, the system will restart the announcement.
- The volume can be adjusted when the system announces the information.
☞ “Volume adjustment” (page 8-11)
- The selected content is read out while the vehicle is being driven, or if parked, you can read the content on the display.

7. Viewing technical information

- Content settings can be made using the Infiniti Connection website. For more details, contact the Infiniti Connection support line at 1-800-334-7858 (for U.S.) /1-855-892-7418 (for Canada) or refer to the Infiniti Connection website www.infiniticonnection.com (for U.S.)/<https://canada.infiniticonnection.com> (for Canada).

Screen information:

When the information feeds downloaded from the Infiniti Connection Data Center while the vehicle is stopped, the contents of the information are displayed.

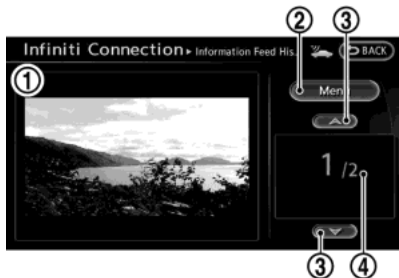

- ① Contents:
The contents of Infiniti Connection feeds are displayed.

- ② [Menu]:
Displays the operation menu.
- ③ [▲]/[▼]:
Turns to the next or previous page if the information has a number of contents page.
- ④ Other information:
The current page number and number of information items are displayed. If there is location or telephone number information, the indicated icon will be displayed.



After park the vehicle in a safe location or when highlight [Infiniti Connection] and push <ENTER>, the operation menu is displayed on the right side of the screen.

INFO:

The availability of the operation menu items differs depending on the contents of the selected information feeds.

UPDATING ALL INFORMATION FEEDS



1. Push <INFO>.
2. Highlight [Infiniti Connection] and push <ENTER>.
3. Highlight [Sync All Information Feeds] and push <ENTER>.

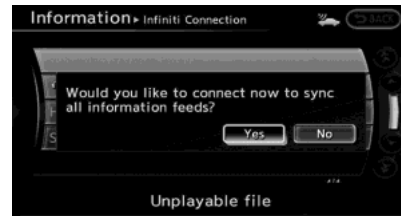

7. Viewing technical information

4. A confirmation message is displayed. Confirm the contents of the message, highlight [Yes] and push **<ENTER>**.
5. The latest information is sent from the Infiniti Connection Response Center and an updated list is displayed.

CONNECTING TO INTERACTIVE VOICE MENU

Various services to support your driving is available by answering Interactive Voice Menu.

For more details, contact the Infiniti Connection support line at 1-800-334-7858 (for U.S.) /1-855-892-7418 (for Canada) or refer to the Infiniti Connection website www.infiniticonnection.com (for U.S.)/
<https://canada.infiniticonnection.com> (for Canada).

1. Push **<INFO>**.
2. Highlight [Infiniti Connection] and push **<ENTER>**.



3. Highlight [Connect to Voice Menu] and push **<ENTER>**.
4. The system connects to the Infiniti Connection Response Center and menu options will be announced. Speak your preferred option.
 - Destination Assistance
Set a destination using a Interactive Voice Response (IVR) system.
 - Roadside Assistance
Connect to the Roadside Response Specialist.
 - Valet Alert
Turns on the Valet Alert function and monitor the vehicle movement in and out of the certain scope.
 - Personal Assistance
Connects to the Infiniti Connection

Response Specialist.

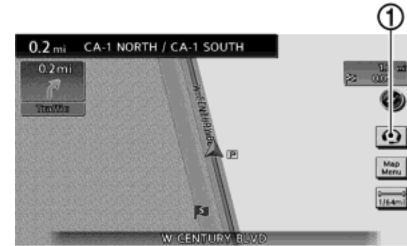

i INFO:

- You can also connect to an Infiniti Connection Interactive Voice Menu using the IVR soft button ① on the map.

i INFO:

- After selecting [Connect to Voice Menu] and pushing **<ENTER>** button, it may take some time until the system initiates connection, depending on the technical environment and whether the TCU (Telematics Communication Unit) is being used by other services.

7. Viewing technical information

- To avoid disconnecting the line, do not turn off the engine or hybrid system.
- The Bluetooth® Hands-free phone system (if so equipped) will be disabled and it will not be possible to take phone calls while the vehicle is connected to the operators at the Infiniti Connection Response Center.
👉 “Notice to Bluetooth® Hands-free phone users” (page 7-6)

VIEWING INFORMATION FEEDS HISTORY

The information feeds that were previously referred to are displayed.

1. Push **<INFO>**.
2. Highlight [Infiniti Connection] and push **<ENTER>**.

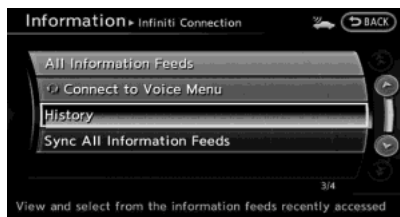

3. Highlight [History] and push **<ENTER>**.



4. Highlight the preferred item and push **<ENTER>**.



5. A history list is displayed. Highlight the preferred information feed.

DELETING INFINITI CONNECTION HISTORY

1. Push **<SETTING>**.
2. Highlight [Others] and push **<ENTER>**.

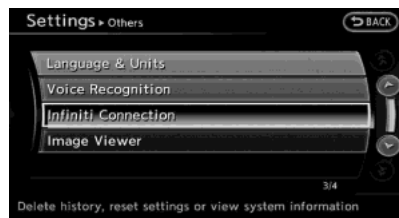

3. Highlight [Infiniti Connection] and push **<ENTER>**.



4. Highlight [Delete History Lists] and push **<ENTER>**.
5. Highlight the preferred item and push **<ENTER>**.

Available items:

- [Delete Information Feed History]:
Delete information feeds history.

7. Viewing technical information

- [Delete Voice Menu History]:
Delete history of Interactive Voice Menu.
 - [Delete Both]:
Delete all history of Infiniti Connection
6. A confirmation message is displayed. Confirm the contents of the message, highlight [Yes] and push **<ENTER>**.

INITIALIZING ALL INFINITI CONNECTION SETTINGS

All Infiniti Connection settings are returned to the default settings.

1. Push **<SETTING>**.
2. Highlight [Others] and push **<ENTER>**.

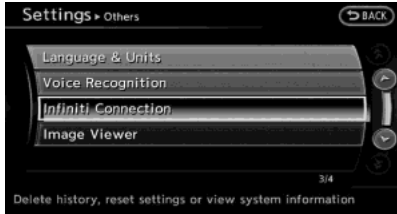

3. Highlight [Infiniti Connection] and push **<ENTER>**.



4. Highlight [Reset All Infiniti Connection Settings] and push **<ENTER>**. A confirmation message is displayed.

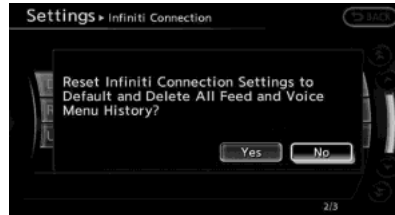

5. Confirm the contents of message, highlight [Yes] and push **<ENTER>**.

DISPLAYING UNIT ID INFORMATION

The necessary information for user registration is displayed.

1. Push **<SETTING>**.

2. Highlight [Others] and push **<ENTER>**.

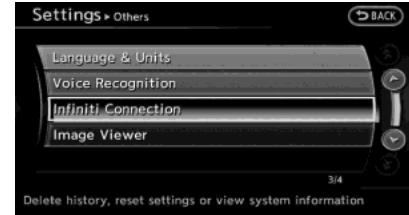

3. Highlight [Infiniti Connection] and push **<ENTER>**.

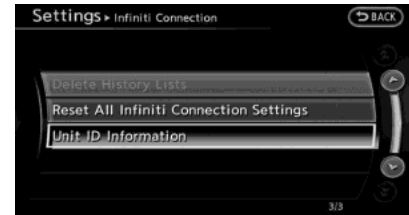

4. Highlight [Unit ID Information] and push **<ENTER>**.

7. Viewing technical information



5. The Unit ID, TCU (Telematics Communication Unit) ID, SIM ID and VIN Information necessary for user registration is displayed.

VOLUME SETTING

The Infiniti Connection Text-to-Speech and Infiniti Connection Response Specialist volume can be set.

EMERGENCY SUPPORT

Infiniti Connection provides various services to support dealing with emergencies of the subscribed vehicle and the driver.

For example, in case of an illness or serious injury, you can seek support by pushing the in-vehicle <SOS> button and connecting to the Infiniti Connection Response Center. The Infiniti Connection Response Center can specify the location of the vehicle via GPS, and the information will

be sent to the police or other agencies as needed.

For information about other Infiniti Connection emergency support related services, contact the Infiniti Connection support line at 1-800-334-7858 (for U.S.) /1-855-892-7418 (for Canada) or refer to the Infiniti Connection website www.infiniticonnection.com (for U.S.)/<https://canada.infiniticonnection.com> (for Canada).



WARNING

- It may not be possible to make an emergency call in all accidents or emergencies.
- Park the vehicle in a safe location and set the parking brake before operating <SOS>.
- Only use this service in case of an emergency. There may be a penalty for inappropriate use of the service.
- The emergency support function cannot be used in the following conditions:
 - The vehicle moves outside the service area where the TCU (Telematics Communication Unit) is connected to the system.

- The vehicle is in a location with poor signal reception such as a tunnel, underground parking, behind a building or in a mountainous area.
- The system will not work if there is an inactive or cancelled subscription.

Making an emergency call



1. Push <SOS> (A).
2. When the line is connected, speak to the Response Specialist.

7. Viewing technical information



INFO:

- After **<SOS>** is pushed, it may take some time until the system initiates connection, depending on the technical environment and whether the TCU (Telematics Communication Unit) is being used by other services.
- An indicator light on **<SOS>** shows the readiness of the emergency support system. If the indicator light is not illuminated, pushing **<SOS>** does not connect your vehicle to the Response Specialist.
The indicator light blinks while connected to the Infiniti Connection Response Center.
- Even when the indicator light is illuminated, connection to the Infiniti Connection Response Center may not be possible. In such cases contact with the police or other agencies should be made using other devices such as telephones.
- To avoid disconnecting the line, do not turn off the engine or hybrid system.
- The Bluetooth® Hands-free phone system will be disabled and it is not possible to take phone calls while the vehicle is connected to the emergency support staff at the Infiniti Connection Response Center.

“Notice to Bluetooth® Hands-free phone users” (page 7-6)

VIEWING INFORMATION ABOUT CURRENT VEHICLE LOCATION

This displays the information about the vehicle location on the route when driving according to route guidance.



BASIC OPERATION

1. Push **<INFO>**.
2. Highlight the preferred item and push **<ENTER>**.
3. Push **<BACK>** to return to the previous screen. Push **<MAP>** to return to the current location map screen.

Contents of vehicle location information

- ① Next Street:
Displays the next street on the route.

7. Viewing technical information

- ② **Current Street:**
Displays the current street on the route.
- ③ **Previous Street:**
Displays the previous street on the route.
- ④ **Displays the distance to the next intersection on the route.**
- ⑤ **Displays the distance traveled from the previous intersection on the route.**

VIEWING AVAILABLE TRAFFIC INFORMATION

NavTraffic information is a subscription service offered by SiriusXM Satellite Radio. This service provides real-time information regarding traffic flow, accidents, road construction and other incidents, where available.

NavTraffic combines information from commercial and public traffic data providers including government departments of transportation, police, emergency services, road sensors, cameras and aircraft reports. The traffic information is broadcast to the vehicle by the SiriusXM satellites. Available traffic information on the route the driver selected is shown on the navigation screen so traffic conditions between you and the destination are known. Three types of real-time traffic information for major roadways are shown on the navigation system:

- * **Unscheduled traffic data** for example, accidents and disabled vehicles.
- * **Scheduled traffic data**, for example road construction and road closures.
- * **Traffic flow information** (rate of speed

data).



WARNING

NavTraffic information is not a substitute for attentive driving. Traffic conditions change constantly and emergency situations can arise without warning. Relying only on NavTraffic information may lead to a collision and could result in serious personal injury.



NOTE:

Flow information is provided only for roads equipped with traffic sensors and is not available in all markets covered by the service. Flow data may not be available on portions of a road that is under construction.

NavTraffic information is available in limited markets. To subscribe or to check if this service is available in the area:

call 1-866-635-2349 or see www.siriusxm.com/navtraffic



INFO:

If a contract is not completed for NavTraffic traffic information service, a message appears, and it will not be possible to check the information on the traffic information system.

7. Viewing technical information



BASIC OPERATION

1. Push **<INFO>**.
2. Highlight [Traffic Info] and push **<ENTER>**.
3. Highlight the preferred information and push **<ENTER>**.
4. Push **<BACK>** to return to the previous screen.

Push **<MAP>** to return to the current location map screen.

Available items

- [Info on Route]:
Displays the list of traffic information found on the recommended route from the current vehicle location to the destination.
- [Nearby Traffic Info]:
Displays the list of traffic information

around the current vehicle location.

INFO ON ROUTE

This is only available when a route is set. The list of traffic information found on the recommended route from the current vehicle location to the destination is displayed. The detailed information about displayed events can also be checked.



1. Highlight [Info on Route] and push **<ENTER>**. A list screen is displayed.

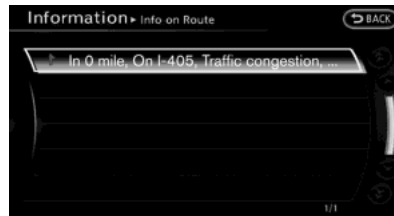

2. Highlight the event to check the detailed information, and push **<ENTER>**.

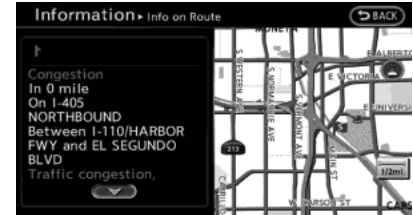

3. The map screen centered around the selected event is displayed. On the left screen, the detailed information about the event is displayed.

The message can be scrolled using the INFINITI controller or the steering wheel.

4. Push **<BACK>** to return to the previous screen.

NEARBY TRAFFIC INFO.

The list of available traffic information around the current vehicle location is displayed.

7. Viewing technical information



1. Highlight [Nearby Traffic Info] and push **<ENTER>**. A list screen is displayed.

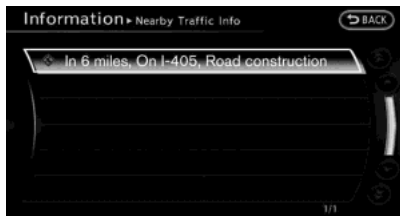

2. Highlight the event to check the detailed information for and push **<ENTER>**.

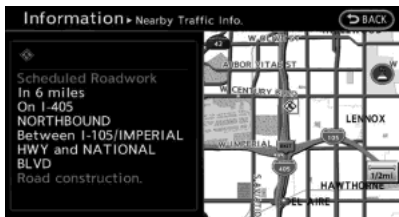

3. The map screen centered around the selected event is displayed. On the left screen, the detailed information about the event is displayed. The message can be scrolled using the INFINITI controller or the steering wheel.
4. Push **<BACK>** to return to the previous screen.

DISPLAY URGENT TRAFFIC INFORMATION

When an urgent event is found around the current vehicle location, a message pops up automatically with a voice announcement.



The message includes the icon, event type, event information and the direct distance from the current location to the event.



INFO:

- Urgent traffic information is displayed regardless of whether the traffic information system is on or off.
- When there are multiple urgent events, the event with the shortest direct distance from the current location is displayed.
- If the urgent event is on the recommended route, and if a detour is found, the detour route notification screen is displayed when the vehicle approaches the detour point.

TRAFFIC INFORMATION ON MAP

With subscription to NavTraffic service, traffic information is displayed on both Plan View and Birdview™ map screen.

 “Notes on NavTraffic information”
(page 10-14)

Screen information

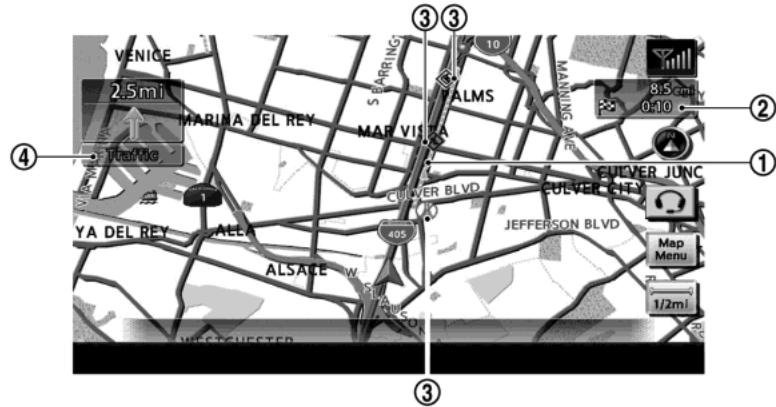

- ① Road conditions
Free Flow: → (Green)
Moderate traffic: → (Yellow)
Heavy traffic: → (Red)
Section affected by serious traffic event:
→ (Purple)
- ② Estimated travel time to destination calculated with consideration of traffic information on route.

- ③ Traffic information icon:
If the route is not already set, all of the traffic information icons on the map screen are displayed in color. When the route is already set, the icons on the route are displayed in color, and the icons outside the route are displayed in gray.

 : Accident

 : Closed road

7. Viewing technical information

 : Information

 : Road work

 : Slippery road

 : Weather

 : Incident

- ④  Traffic indicator:
Displays the reception condition of traffic information transmitted from the provider.
Green: Reception condition is good.
Gray: Reception condition is not good.
No mark: Subscription to NavTraffic service is not detected.

Traffic information display and scale levels

2D map and Birdview Map	
5 miles	10 km
2 miles	4 km
1 mile	2 km
1/2 mile	1 km
1/4 mile	500 m
1/8 mile	200 m

1/16 mile	100 m
1/32 mile	50 m
1/64 mile	25 m

Checking detailed information for traffic information icons on map



1. Place the cross pointer over the traffic information icon. The general description of the icon is displayed.
2. Push **<ENTER>** or touch [Detail]. The screen for showing the detailed information for the traffic information icon is displayed.

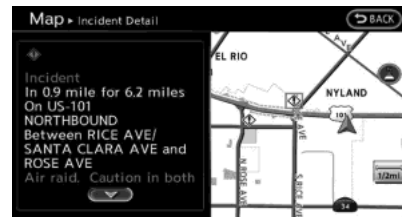

3. The map screen centered around the selected event is displayed. On the left screen, the detailed information about the event is displayed. You can scroll the message by using the INFINITI controller or the steering wheel.
4. Push **<MAP>** to return to the current location map screen.

TRAFFIC INFORMATION SETTINGS

This displays or changes the settings for the traffic information related functions.



1. Push **<SETTING>**.
2. Highlight [Navigation] and push **<ENTER>**.
3. Highlight [Traffic Info Settings] and push **<ENTER>**.



4. Highlight the preferred setting and push **<ENTER>**. The indicator for the selected setting illuminates.

Available setting items

- Use Traffic Info.:
Enables all traffic information related functions.
- Show Incidents on Map:
Displays the traffic incidents (e.g., accident) on the map screen.
- Show Traffic Flow on Map:
Displays the traffic flow with an arrow on the map screen.

- Blink Red Traffic Flow:
Blinks the red traffic flow lines that represent congestions.
- Traffic Announcements:
Announces the traffic information event on the route.

INFO:

- Even when “Show Traffic Flow on Map” and “Show Incidents on Map” are set to off, the list display of “Info on Route” and “Nearby Traffic Info” will not be affected.
- Even when “Traffic Announcement” is set to off, the route guidance will not be affected. Also, the announcement of emergency information and weather information will not be turned off.



Voice command

1. Push **<TALK >** located on the steering wheel.
2. After the tone sounds, speak a command.

To turn on or off the traffic information system:

“Information” “Traffic Information”

(Standard Mode)

“Traffic Information” (Alternate Command Mode)

7. Viewing technical information

VIEWING AVAILABLE WEATHER INFORMATION

NavWeatherXM information is a subscription service offered by SiriusXM Satellite Radio.

This service provides real-time information regarding current weather, temperature, warnings, road conditions and forecasts where available. The weather information is broadcast to the vehicle by the SiriusXM Satellite Radio.

The service enables you to view the following information on the navigation system:

*Current weather information icon of the destination on the screen of suggested route

*Detailed weather information and forecasts of an area of interest

*Countrywide and local maps with the current weather, temperature, warnings and road condition information

*List of warning/watches events detected around the current location

*Pop-up messages on the navigation screen with voice announcements when warnings and watches are detected around

the current location



WARNING

NavWeatherXM information is not a substitute for attentive driving. Weather conditions change constantly and emergency situations can arise without warning. Relying only on NavWeatherXM information could result in serious personal injury.

NavWeatherXM information is available in limited markets. To subscribe to or check if this service is available in the area, call 1-866-635-2349 or access www.siriusxm.com/navweather.



INFO:

- If a contract is not completed for the NavWeatherXM information service, a message appears and it will not be possible to check the information on the traffic information system.
- The weather information is available only for areas that provide weather information to NavWeatherXM.



INFO:

The reception condition of the SiriusXM Weather information transmitted from the provider can be confirmed using the “Weather” indicator on the upper right side of the screen.

Green: The reception condition is good.

Gray: The reception condition is not good.

No mark: A subscription to the NavWeatherXM service is not detected.

7. Viewing technical information

DISPLAYING WEATHER INFORMATION SCREEN

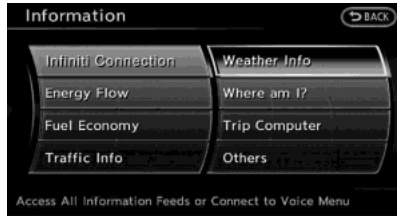

Basic Operation

1. Push **<INFO>**.
2. Highlight [Weather Info] and push **<ENTER>**.
3. Highlight the preferred information and push **<ENTER>**.
4. Push **<BACK>** to return to the previous screen. Push **<MAP>** to return to the current location map screen.

Available items

- **Current Weather and Forecasts:**
Displays current weather information and three-day forecasts.
- **Warnings and Watches History:**
Displays a list of warnings and watches recently detected around the current

location.

- **Weather Map:**
Displays the current weather map for the preferred area.
- **Temperature Map:**
Displays the current temperature map for the preferred area.
- **Warnings Map:**
Displays the current watches/warnings map for the preferred area.
- **Road Condition Map:**
Displays the current road condition map for the preferred area.

Selecting city

When displaying various weather information screens by pushing **<INFO>**, the range can be specified for the weather information from among the current location (local), destination, countrywide (nation) or a specified city.

The city can be specified by selecting one from the list that is displayed.



1. Push **<INFO>**.
2. Highlight [Weather Info] and push **<ENTER>**.



3. Highlight the preferred information and push **<ENTER>**.

7. Viewing technical information



4. Highlight [Select Other City from Menu] and push **<ENTER>**.

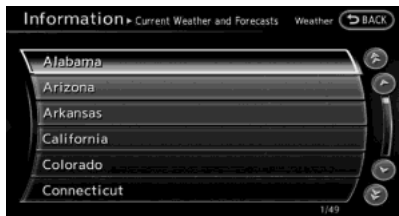

5. Highlight the preferred state from the list and push **<ENTER>**.

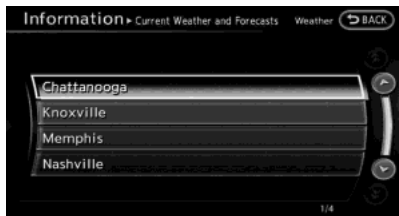

6. Highlight the preferred city from the list and push **<ENTER>**.



INFO:

[Select Other City from Menu] is not available while driving.

Current weather and forecasts

The current weather information and a three-day forecast can be displayed for the current location, the destination or the preferred city.



1. Highlight [Current Weather and Forecasts] and push **<ENTER>**.



2. Highlight the preferred area and push **<ENTER>**.



INFO:

- [Weather Info on Destination] is not available unless a destination is set for the route guidance.
- When a destination is not set, nearby weather information is displayed.



7. Viewing technical information

3. A weather information screen is displayed. Highlight [Forecast] and push **<ENTER>**.

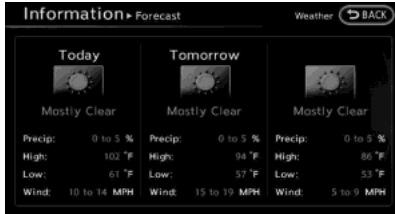

4. The forecast screen is displayed. A three-day forecast can be confirmed for the preferred area.
5. Push **<BACK>** to return to the previous screen. Push **<MAP>** to return to the current location map screen.



Voice command

1. Push **<TALK>**  located on the steering wheel.
2. After the tone sounds, speak a command.
To display the list for weather information:
"Weather Information" (Alternate Command Mode)

Warnings and watches history

A list can be displayed for the warning/watch events detected around the current location. The detailed information of each event can also be displayed.



1. Highlight [Warnings and Watches History] and push **<ENTER>**. A list warning/watch events around the current location is displayed.



2. Highlight the event to check the detailed information and push **<ENTER>**.

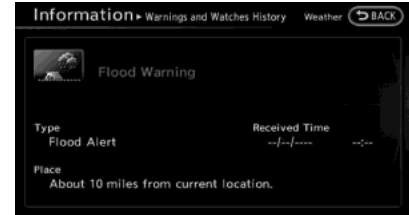

3. A screen with detailed information of the event is displayed.
4. Push **<BACK>** to return to the previous screen. Push **<MAP>** to return to the current location map screen.

Weather Map

The current weather map can be confirmed for the current location, the destination, the entire country or the preferred city.



7. Viewing technical information

1. Highlight [Weather Map] and push **<ENTER>**



2. Highlight the preferred map area push **<ENTER>**

INFO:

[Destination Map] is not available unless a destination is set for the route guidance.



3. A weather map is displayed. The weather and precipitation level are shown by colors.

4. Push **<BACK>** to return to the previous screen. Push **<MAP>** to return to the current location map screen.



INFO:

Touch [Legend] to display the map legend.

Voice command

1. Push **<TALK>** located on the steering wheel.
2. After the tone sounds, speak a command.

To display the list for weather map: "Weather Map" (Alternate Command Mode)

Temperature Map

The current temperature map can be confirmed for the current location, the destination, the entire country or the preferred city.



1. Highlight [Temperature Map] and push **<ENTER>**.



2. Highlight the preferred map area and push **<ENTER>**.

7. Viewing technical information



INFO:

- [Destination Map] is not available unless a destination is set for the route guidance.
- When a destination is not set, a nearby weather map is displayed.



3. A temperature map is displayed. The temperature information is shown by numbers and colors.
4. Push **<BACK>** to return to the previous screen. Push **<MAP>** to return to the current location map screen.

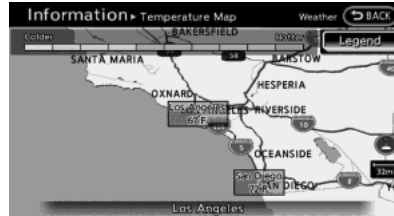

INFO:

Touch [Legend] to display the map legend.

Warnings Map

The current warning/watch information can be confirmed for the current location, the destination, the entire country or the preferred city.



1. Highlight [Warnings Map] and push **<ENTER>**.

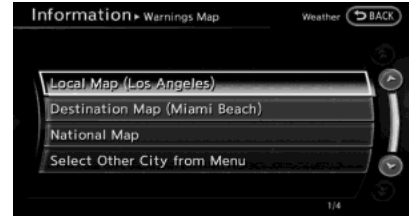

2. Highlight the preferred map area and push **<ENTER>**.



INFO:

[Destination Map] is not available unless a destination is set for the route guidance.

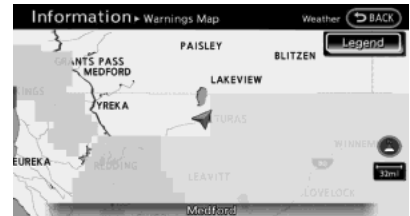

3. A warning/watch map is displayed. Warning and watch information is shown by colors.
4. Push **<BACK>** to return to the previous screen. Push **<MAP>** to return to the

7. Viewing technical information

current location map screen.

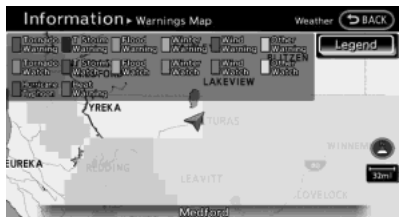

INFO:

Touch [Legend] to display the map legend.

Road Condition Map

The current road condition can be confirmed for the current location, the destination, the entire country or the preferred city.



1. Highlight [Road Condition Map] and push **<ENTER>**.

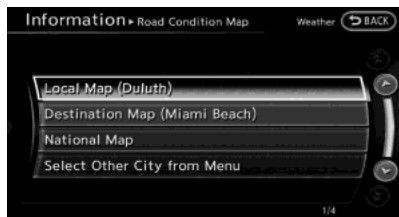

2. Highlight the preferred map area and push **<ENTER>**.



INFO:

[Destination Map] is not available unless a destination is set for the route guidance.



3. A road condition map is displayed. The road conditions are shown by colors.

4. Push **<BACK>** to return to the previous screen. Push **<MAP>** to return to the current location map screen.



INFO:

Touch [Legend] to display the map legend.

DESTINATION WEATHER ON SUGGESTED ROUTE SCREEN



















On the screen of the suggested route after setting a destination, the current weather information around the destination is

7. Viewing technical information

displayed via icons.

Weather information icons

Clear	
Mostly Clear	
Partly Cloudy	
Mostly Cloudy	
Cloudy	
Haze	
Fog	
Rain, Light Rain	
Hail	
Heavy Rain	
Freezing Rain/Ice	
Snow	
Heavy Snow	
Dust/Sand	
Smoke/Ash	
Thunderstorm	

Tornado/Funnel Cloud	
-------------------------	---

AUTOMATICALLY DISPLAY WARNINGS/WATCHES

When an urgent warning/watch is detected around the current vehicle location, a message pops up automatically with a voice announcement.



The message includes the weather icon and text describing the event.

INFO:

- The pop-up messages and announcements can be set to on or off.
 “Weather information settings” (page 7-29)
- If multiple warning/watch events are detected, they will be displayed in order

starting with the one having the shortest linear distance from the vehicle.

Weather information settings

The settings can be confirmed and changed for the urgent weather information related functions.



1. Push **<SETTING>**.
2. Highlight [Navigation] and push **<ENTER>**.
3. Highlight [Weather Info Setting] and push **<ENTER>**.
4. Highlight the preferred setting and push **<ENTER>**. The indicator for the setting illuminates.

7. Viewing technical information

Available setting items

- Display an Alert for Weather Warnings: Displays a message screen automatically when the system detects urgent warning information.
- Display an Alert for Weather Watches: Displays a message screen automatically when the system detects urgent watch information.
- Voice Announcements: Provides urgent information announcements for warnings and watches around the current location.

Types of warnings/watches

Category	Warnings/Watches
Tornado	Tornado Watch, Tornado
Hurricane	Inland Hurricane Wind, Hurricane Force Wind, Hurricane, Typhoon
Storm	Severe Thunderstorm Watch, Severe Thunderstorm, Storm, Tropical Storm, Inland Tropical Storm, Dust Storm
Flood	Flood Watch, Flash Flood, Coastal Flood, Lakeshore Flood, High Surf, Flood

Category	Warnings/Watches
Winter	Winter Watch, Heavy Snow, Heavy Sleet, Lake Effect Snow, Freeze, Heavy Freezing Spray, Blizzard, Ice Storm, Winter Storm
Wind	Wind Watch, High Wind, Wind Chill, Gale
Extremes	Excessive Heat
Other	Red Flag, Tsunami, Avalanche, Special Marine, Earthquake, Law Enforcement, Hazardous Materials, Nuclear Power Plant, Radiological Hazard, Civil Danger, Fire, Shelter in Place, Volcano, Other Watches, Other Warnings



INFO:

- The “Other Watches” category in the “Other” category includes Inland Hurricane Watch, Hurricane Watch, Typhoon Watch, Tropical Storm Watch, Inland Tropical Storm Watch and Fire Weather Watch.
- The “Other Warnings” category in the “Other” category includes Dense Fog Warning, Freezing Fog Warning, Extreme Cold Warning, Frost Warning, Hydrologic Warning, Ashfall Warning, Air Stagnation Warning, Low Water Warning, Ice Accretion

Warning, Dense Smoke Warning, Dense Smoke Advisory, Freezing Fog Advisory, Dense Fog Advisory, Ashfall Advisory and Air Stagnation Advisory.

MAP UPDATE

The map database of the navigation system can be updated.

1. Push **<INFO>**.



2. Highlight [Map Update] and push **<ENTER>**.
3. To update the map data, insert the first of the map update DVDs.

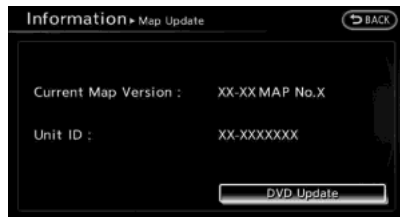

4. Highlight [DVD Update] and push **<ENTER>**.

INFO:

- Refer to the vehicle Owner's Manual for the location of the DVD slot.
- Do not eject the DVD while updating the map data. Doing so will result in an incomplete update.
- Multiple DVDs are required to fully update the system. In addition, a Digital Rights Management (DRM) activation code is required to complete the installation. To purchase a map update and DRM code, contact the INFINITI NAVIGATION SYSTEM HELPDESK. See the contact information on the inside front cover of this manual. You will need your Unit ID in order to purchase a map update.

 "Viewing navigation system unit identification" (page 7-32)

NOTE:

In handling the DVD-ROM, be careful on the following points.

- Do not try to bend the DVD-ROM. Do not use any disk that is bent or cracked.
- Do not use any benzine, thinner, or anti-static spray on them.

- Do not put on any sticker or write anything on either surface.
- If you need to clean it, do so with a soft cloth by wiping from the centre outward.
- Do not use a DVD Laser Lens Cleaners as they may cause the DVD player to malfunction.

7. Viewing technical information

VIEWING NAVIGATION SYSTEM UNIT IDENTIFICATION

The navigation system unit identification number and the current map version can be located.

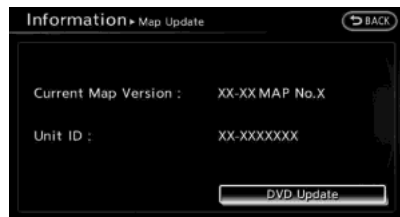

BASIC OPERATION

1. Push **<INFO>**.
2. Highlight [Map Update] and push **<ENTER>**.
3. The unit Identification (Unit ID) number is displayed.
4. Push **<BACK>** to return to the previous screen. Push **<MAP>** to return to the current location map screen.

“Map update” (page 7-31)

VIEWING NAVIGATION SYSTEM VERSION INFORMATION

This displays the map version information.



BASIC OPERATION

1. Push **<INFO>**.
2. Highlight [Navigation Version] and push **<ENTER>**.
3. Push **<BACK>** to return to the previous screen. Push **<MAP>** to return to the current location map screen.

VIEWING GPS CURRENT LOCATION INFORMATION

This displays GPS information, such as the positioning status, latitude/longitude, altitude and satellite locations.

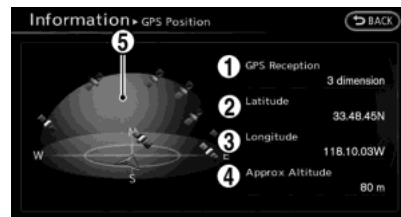

BASIC OPERATION

1. Push **<INFO>**
2. Highlight [Others] and push **<ENTER>**.
3. Highlight [GPS Position] and push **<ENTER>**.
4. Push **<BACK>** to return to the previous screen. Push **<MAP>** to return to the current location map screen.

Contents of GPS information

① GPS Reception:

Displays the GPS positioning method.

3-dimension	Calculating the latitude, longitude and altitude by four or more satellites.
2-dimension	Calculating the latitude, longitude and altitude by three or more satellites.
Out of range	Cannot calculate because no GPS satellites can be located.

② Latitude:

Displays the latitude.



③ Longitude:

Displays the longitude.

④ Approx Altitude:

Displays the approximate altitude.

⑤ Positioning status:

 (green)	Satellites are available.
 (gray)	Satellites are being searched for.

7. Viewing technical information

MEMO

8 Other settings

Settings screen	8-2	Delete stored items	8-10
Basic operation.....	8-2	Reset all navigation settings to default.....	8-10
Display settings	8-3	Volume adjustment.....	8-11
Basic operation.....	8-3	Basic operation	8-11
Display adjustment	8-3	Clock settings.....	8-12
Setting color theme.....	8-5	Basic operation	8-12
Navigation setting	8-5	Language and unit settings.....	8-13
Basic operation.....	8-5	Language settings	8-13
Speed limit indication on map.....	8-6	Unit settings.....	8-14
Other navigation settings.....	8-7		

8. Other settings

SETTINGS SCREEN

The navigation system can be customized to make it easier for you to use.

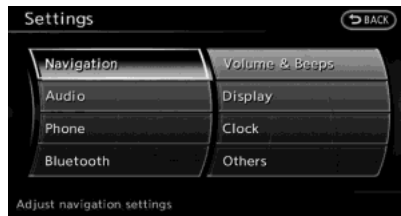

BASIC OPERATION

1. Push **<SETTING>**.
2. Highlight the preferred setting item and push **<ENTER>**.

Available setting items

- [Navigation]:
Adjust various settings of the navigation system.
👉 “Navigation setting” (page 8-5)
- [Audio]:
Refer to the vehicle Owner’s Manual.
- [Phone]:
Refer to the vehicle Owner’s Manual.
- [Bluetooth]:
Set Bluetooth® Audio and Phone.
Refer to the vehicle Owner’s Manual.
- [Volume & Beeps]:
👉 “Volume adjustment” (page 8-11)
- [Rear Display] (if so equipped):
Refer to the vehicle Owner’s Manual.
- [ECO DRIVE] (if so equipped):
Refer to the vehicle Owner’s Manual.
- [Driver Assistance] (if so equipped):
Refer to the vehicle Owner’s Manual.
- [Others]:
 - [Rear Display] (if so equipped):
Refer to the vehicle Owner’s Manual.
 - [Display]:
👉 “Display settings” (page 8-3)
 - [Comfort]:
This item is displayed when the ignition switch is in the ON position.
Refer to the vehicle Owner’s Manual.
 - [Language & Units]:
👉 “Language and unit settings” (page 8-13)
 - [Clock]:
👉 “Clock settings” (page 8-12)
 - [Voice Recognition]:
👉 “System feedback announcement modes” (page 9-14)
 - [Infiniti Connection] (if so equipped):
👉 “Infiniti Connection™” (page 7-3)
 - [Camera] (if so equipped):
Refer to the vehicle Owner’s Manual.
 - [Sonar] (if so equipped):
Adjust the parking sonar detection sensitivity, etc.
Refer to the vehicle Owner’s Manual.
 - [Image Viewer]:
Refer to the vehicle Owner’s Manual.



INFO:

The displayed items vary depending on the equipped options.

DISPLAY SETTINGS

This menu turns on and off the display, adjusts the image quality of the navigation screen and changes the color of the menu screen.

BASIC OPERATION



1. Push **<SETTING>**.
2. Highlight [Display] and push **<ENTER>**.
3. Highlight the preferred adjustment item and push **<ENTER>**.



INFO:

If a rear display is equipped, it is possible to select [Display] after pushing **<SETTING>**, highlighting [Others] and then pushing **<ENTER>**.

Available setting items

- [Display Adjustment]
Turn on and off the display and adjust the image quality of the navigation screen.
- [Color Theme]
Set the color of the menu screen.

DISPLAY ADJUSTMENT

This menu turns on and off the display and adjusts the image quality of the navigation screen.

Basic operation

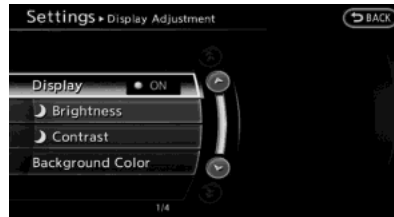

1. Highlight [Display Adjustment] and push **<ENTER>**.
2. Highlight the preferred adjustment item and push **<ENTER>**.
3. Use the INFINITI controller to adjust to the preferred setting.

4. After setting, push **<ENTER>** or **<BACK>** to apply the setting.
5. Highlight **<BACK>** to return to the previous screen. Push **<MAP>** to return to the current location map screen.

Available setting items

- [Display]:
Turn on or off the screen.
]Ⓜ "Display" (page 8-4)
- [Brightness]:
Adjust the screen brightness.
]Ⓜ "Brightness" (page 8-4)
- [Contrast]:
Adjust the screen contrast.
]Ⓜ "Contrast" (page 8-4)
- [Background Color]:
Set the background color.
]Ⓜ "Background color" (page 8-4)

8. Other settings

Display

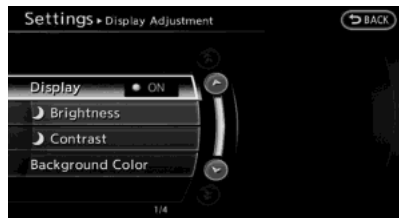

To turn off the display, push **<ENTER>**.

The display can also be turned off by pushing and holding **<DAY/NIGHT OFF>** for more than 2 seconds.

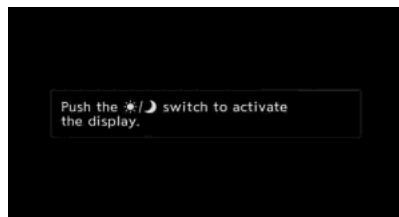

When any button is pushed with the display off, the display turns on. The display will automatically turn off when there is no switch operation for 5 seconds. To turn on the display, push **<DAY/NIGHT OFF>**.

Brightness

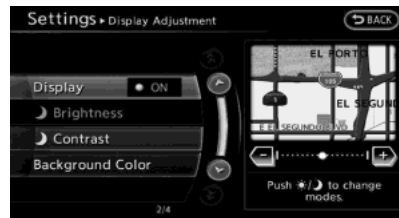

Adjust the display brightness by rotating the center dial in the [+] or [-] direction on the INFINITI controller.

Contrast

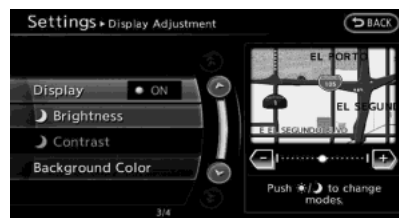

Adjust the display contrast by rotating the center dial in the [+] or [-] direction on the INFINITI controller.

Background color

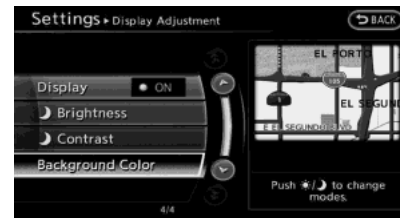

Select to toggle between the day screen and night screen.



Day screen



Night screen



INFO:

The background color setting can also be changed using the **<DAY/NIGHT OFF>**.

SETTING COLOR THEME

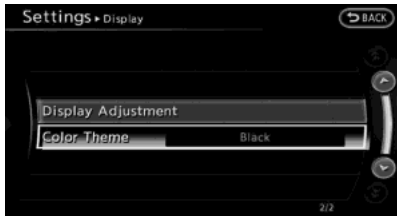

1. Highlight [Color Theme] and push **<ENTER>**.



2. Highlight the preferred menu color and push **<ENTER>**.

NAVIGATION SETTING

The navigation system can be customized to your preferences.

BASIC OPERATION

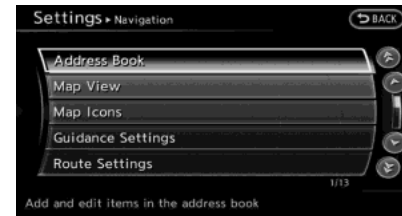

1. Push **<SETTING>**.
2. Highlight [Navigation] and push **<ENTER>**.
3. Highlight the preferred setting item and push **<ENTER>**.

Available setting items

- [Address Book]:
Store locations and routes, and edit the stored items.
☞ “Storing location” (page 6-2)
- [Map View]:
Set the display method and the direction of the map.

8. Other settings

- ☞ “Changing map view” (page 3-11)
- [Map Icons]:
Set the map icons to display on the map.
 - ☞ “Displaying map icons” (page 3-18)
- [Guidance Settings]:
Set the various functions for the route guidance.
 - ☞ “Guidance settings” (page 5-21)
- [Route Settings]:
Change the routing preferences.
 - ☞ “Detailed route settings” (page 5-26)
- [Traffic Info Settings]:
Set the various functions of the NavTraffic information system.
 - ☞ “Traffic information settings” (page 7-20)
- [Weather Info Setting]:
Set the functions of the NavWeatherXM information system.
 - ☞ “Weather information settings” (page 7-29)
- [Speed Limit Info]:
Display speed limit information.
 - ☞ “Speed limit indication on map” (page 8-6)
- [Others]:
Display other setting items.
 - ☞ “Other navigation settings” (page 8-7)
- [Delete Stored Information]:
Delete stored locations and the home setting in the Address Book.
 - ☞ “Delete stored items” (page 8-10)
- [Delete Connected Search History] (if so equipped):
Delete all connected search histories.
 - ☞ “Delete stored items” (page 8-10)
- [Delete All Previous Destinations]:
Delete all previous destinations.
 - ☞ “Delete stored items” (page 8-10)
- [Delete Previous Starting Point]:
Delete all previous starting points.
 - ☞ “Delete stored items” (page 8-10)
- [Reset All Navigation Settings to Default]:
Reset all of the settings to default.
 - ☞ “Reset all navigation settings to default” (page 8-10)

SPEED LIMIT INDICATION ON MAP

Turn the [Speed Limit Info] display on or off. The indicator light illuminates when the speed limit display function is set to on.



1. Highlight [Speed Limit Info] and push **<ENTER>**.

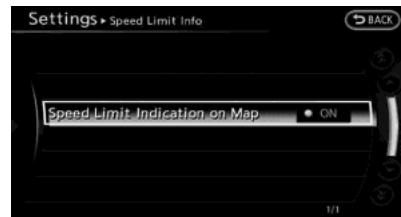

2. Highlight [Speed Limit Indication on Map] to toggle the function between on and off. The indicator light illuminates when the speed limit display function is set to on.

OTHER NAVIGATION SETTINGS



Basic Operation

1. Push **<SETTING>**.
2. Highlight [Navigation] and push **<ENTER>**.
3. Highlight [Others] and push **<ENTER>**.
4. Highlight the preferred setting item and push **<ENTER>**.

Available setting items

- [Audio Display on Map]:
Allows the audio information to be displayed at all times.
☞ “Displaying audio information on map screen” (page 8-7)
- [Small Step Zoom by Dial]:
Sets the free zoom function on or off. When this setting is on, it is possible to adjust the scale in smaller steps than

with normal scale adjustment.

- [Map Scrolling Information]:
Sets the system so that when the map scrolls the information about the location aligned at the center of the cross pointer is displayed.
☞ “Map scrolling information” (page 3-19)
- [Customize Nearby Places]:
Set the category of frequently visited landmarks.
☞ “Customizing Nearby Places” (page 8-8)
- [Keyboard Type]:
Switches the keyboard layout for the character input screen.
☞ “Settings keyboard layout of character input screen” (page 8-8)
- [North Up when Zoom Out]:
When this setting is ON, the orientation of the map is automatically changed to North Up when the widest map scale is selected. The orientation is changed to North Up even when Heading Up is set.
- [Adjust Current Location]:
Corrects the position of the current location.

☞ “Adjusting current vehicle location” (page 8-9)

Displaying audio information on map screen

The operating status of audio functions can be displayed on the map screen.

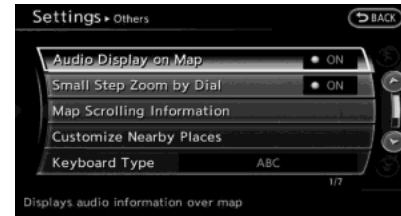

1. Highlight [Others] and push **<ENTER>**.
2. Highlight [Audio Display on Map] and push **<ENTER>**. The indicator illuminates when the item is set.
3. Push **<MAP>** to return to the current location map screen.

8. Other settings



4. On the bottom of the map screen, the operating status of an audio/visual function is displayed at all times.

Customizing Nearby Places

The categories can be customized for searching places of interest nearby.

The modified list of places of interest can be used for searching for a location using [Places].

- 🗨️ “Searching for destinations”
(page 2-21)

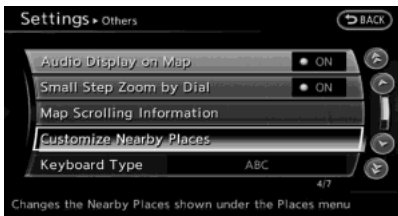

1. Highlight [Others] and push **<ENTER>**.
2. Highlight [Customize Nearby Places] and push **<ENTER>**.

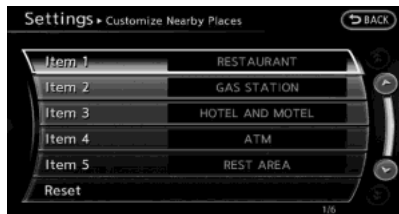

3. Highlight the preferred item and push **<ENTER>**. The main category list is displayed.



4. Highlight a main category and push **<ENTER>**. The sub category list is displayed. Highlight [Category Search] and push **<ENTER>**. The preferred category can also be input directly.



5. Highlight a sub category and push **<ENTER>**. The category setting is modified.
6. Push **<MAP>** to return to the current location map screen.

Settings keyboard layout of character input screen

Depending on the user's preference for the keyboard layout of character input screen, the ABC layout or QWERTY layout can be selected.

Example: Switching to the QWERTY layout



1. Highlight [Others] and push **<ENTER>**.
2. Highlight [Keyboard Type] and push **<ENTER>**.

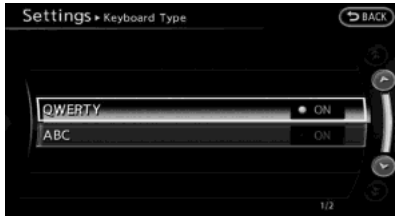

3. Highlight [QWERTY] and push **<ENTER>**. The indicator illuminates when the item is set.
4. Push **<MAP>** to return to the current location map screen.



ABC layout



QWERTY layout

Adjusting current vehicle location

If the vehicle icon indicating the current vehicle location is not in the correct position, the location of the vehicle icon on the map screen can be adjusted.

INFO:

- Regardless of the map view setting, the map is displayed in Plan View when adjusting the position of the vehicle icon.

- When correcting the position of the vehicle icon, the map is automatically displayed in the North Up mode. After finishing the correction, the map restores the current orientation setting.
- The position and direction of the vehicle icon may be misaligned depending on the external conditions and environment.
- If the vehicle icon is misaligned, drive for a while in a location where the GPS signals can be received. This may correct the position of the vehicle icon.

 "Vehicle icon" (page 11-4)

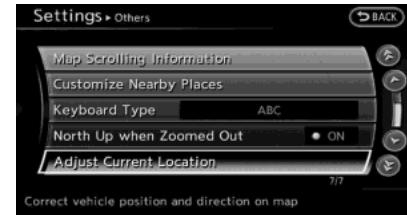

1. Highlight [Others] and push **<ENTER>**.
2. Highlight [Adjust Current Location] and push **<ENTER>**. The current location map screen is displayed.

8. Other settings

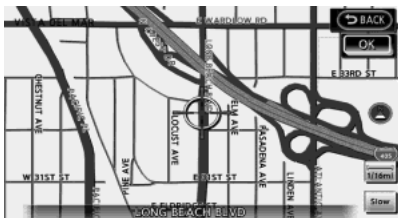

- Adjust the position of the vehicle icon. After adjusting the position of the vehicle icon, push **<ENTER>**.

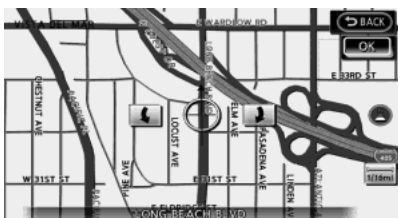

- Adjust the direction of the vehicle icon. After adjusting the direction of the vehicle icon, push **<ENTER>**.



- A message is displayed, and the adjusted vehicle location is stored.

DELETE STORED ITEMS

Delete stored item from setting screen.

Basic Operation

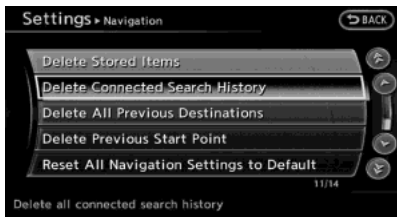

- Highlight [Navigation] and push **<ENTER>**.
- Highlight the preferred item that you want to delete and push **<ENTER>**.

Available items

- [Deletes Stored Information]: Delete the stored location and home.
- [Deletes Connected Search History] (if so equipped): Delete the Infiniti Connection™ search history.
- [Delete All Previous Destinations]: Delete all previous destinations.
- [Delete Previous Start Point]: Delete all previous start point.

RESET ALL NAVIGATION SETTINGS TO DEFAULT

This restores various settings (display, volume level, etc.) to the default settings.



INFO:

The memory contents, such as the stored locations, will not be deleted.

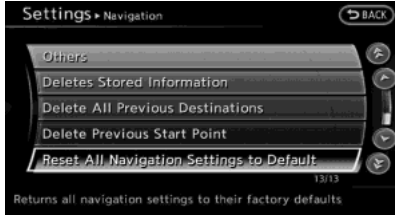

1. Highlight [Navigation] and push **<ENTER>**.
2. Highlight [Reset All Navigation Settings to Default] and push **<ENTER>**.

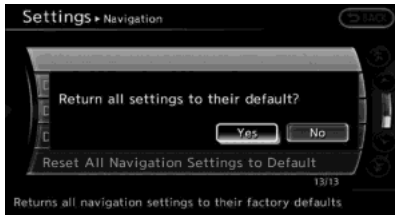

3. A confirmation message is displayed. Confirm the contents of the message, highlight [Yes] and push **<ENTER>**.

VOLUME ADJUSTMENT

This turns on and off, as well as adjusts, the phone function (ringer, incoming and outgoing volume), the voice guide function, Infiniti Connection function (if so equipped) and the beep function.

BASIC OPERATION

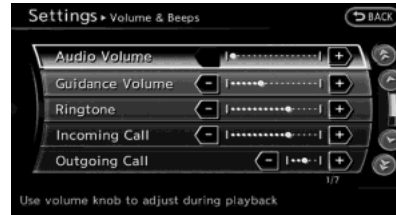

1. Push **<SETTING>**.
2. Highlight [Volume & Beeps] and push **<ENTER>**.
3. Highlight the preferred adjustment item and push **<ENTER>**.
4. Use the INFINITI controller to adjust the volume. Push **<ENTER>** to set to on or off.
5. After setting, push **<ENTER>** or **<BACK>** to apply the setting.

6. Push **<BACK>** to return to the previous screen. Push **<MAP>** to return to the current location map screen.

Available setting items

- [Audio Volume]:
Adjust the volume level of the audio system using the INFINITI controller in the direction of [+] or [-].
- [Guidance Volume]:
Adjust the volume level of voice guidance using the INFINITI controller in the direction of [+] or [-].
- [Ringtone]:
Adjust the volume level of the ringtone using the INFINITI controller in the direction of [+] or [-].
- [Incoming Call]:
Adjust the incoming call volume using the INFINITI controller in the direction of [+] or [-].
- [Outgoing Call]:
Adjust the outgoing call volume using the INFINITI controller in the direction of [+] or [-].
- [Infiniti Connection] (if so equipped):
Adjust the Infiniti Connection volume

8. Other settings

using the INFINITI controller in the direction of [+] or [-].

- [Switch Beeps]:
Select to toggle the beep function between on and off. The indicator light illuminates when the beep function is set to on. The beep sounds when pushing and holding a button or when a prohibited operation is performed.
- [Guidance Voice]:
Select to toggle the voice guidance function between on and off. The indicator light illuminates when the voice guidance function is set to on.

INFO:

For more details about [Ringtone], [Incoming Call] and [Outgoing Call], refer to the vehicle Owner's Manual.

CLOCK SETTINGS

This changes the clock settings.

BASIC OPERATION



1. Push **<SETTING>**.
2. Highlight [Clock] and push **<ENTER>**.
3. Highlight the preferred adjustment item and push **<ENTER>**.
4. Use the INFINITI controller to adjust to the preferred setting. Push **<ENTER>** to set on or off.
5. After setting, push **<ENTER>** or **<BACK>** to apply the setting.
6. Push **<BACK>** to return to the previous screen. Push **<MAP>** to return to the current location map screen.

Available setting items

- [On-screen Clock]:
Select to toggle the clock display located in the top right corner of the display between on and off. The indicator light illuminates when the clock display is set to on.
- [Clock Format (24h)]:
Select the clock format between 12-hour and 24-hour times. The indicator light illuminates when the clock is set to the 24-hour format.
- [Offset (hour)]:
Use the INFINITI controller or the center dial to adjust the offset value (between -12 and +12).
- [Offset (min)]:
Use the INFINITI controller or the center dial to adjust the offset value (between -59 and +59).
- [Daylight Savings Time]:
Select to toggle the daylight savings time setting between on and off. The indicator light illuminates when the daylight savings time setting is set to on.

- [Time Zone]:
Select an appropriate time zone from the list that appears when this item is highlighted.
 - Pacific
 - Mountain
 - Central
 - Eastern
 - Atlantic
 - Newfoundland
 - Hawaii
 - Alaska

LANGUAGE AND UNIT SETTINGS

This changes the language and measurement unit used in the system.

LANGUAGE SETTINGS

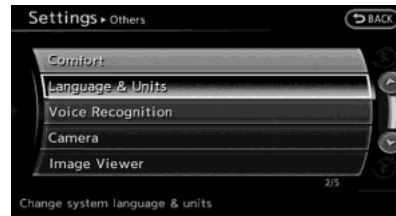

1. Push **<SETTING>**.
2. Highlight [Others] and push **<ENTER>**.
3. Highlight [Language & Units] and push **<ENTER>**.

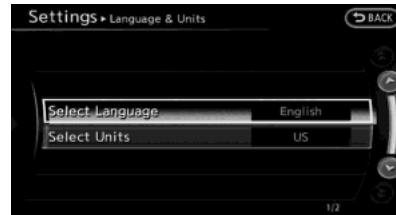

4. Highlight [Select Language] and push **<ENTER>**.

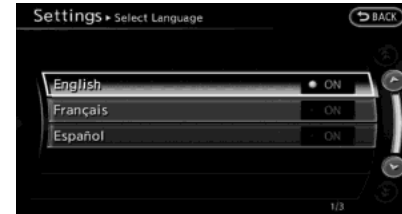

5. Highlight the preferred setting item and push **<ENTER>**. The indicator light of the selected item illuminates.

Available languages

- [English]
- [Français]
- [Español]

! NOTE:

Do not change the ignition switch position while changing the language. Doing so may cause a system malfunction.

8. Other settings

UNIT SETTINGS

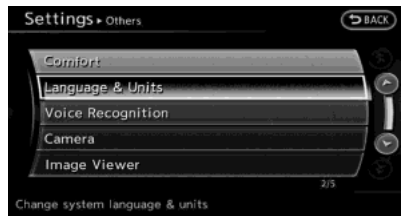

1. Push **<SETTING>**.
2. Highlight [Others] and push **<ENTER>**.
3. Highlight [Language & Units] and push **<ENTER>**.



4. Highlight [Select Units] and push **<ENTER>**.

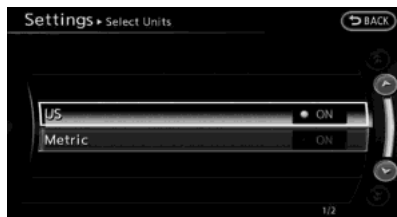

5. Highlight the preferred unit and push **<ENTER>**. The indicator of the selected unit illuminates.

Available units

- US:
mile, MPH, °F, MPG
 - Metric:
km, km/h, °C, L/100 km
6. Push **<BACK>** to return to the previous screen. Push **<MAP>** to return to the current location map screen.

INFO:

- [Select Units] and/or [Select Units (Tire Pressure)] may be displayed depending on the vehicle model and equipment. Refer to the vehicle Owner's Manual.

9 Voice recognition

INFINITI Voice Recognition	9-2	Confirming how to use voice commands	9-10
Standard mode	9-2	Using voice recognition system	9-13
Confirming how to use voice commands.....	9-2	Before starting	9-13
Using voice recognition system	9-4	Giving voice commands	9-13
Before starting	9-4	System feedback announcement modes	9-14
Giving voice commands.....	9-4	Setting alternate command mode	9-14
Voice command examples	9-5	Speaker adaptation	9-15
Alternate command mode.....	9-9	Voice command examples	9-17
Displaying how to operate voice		Command lists (Standard mode).....	9-20
recognition system.....	9-9	Command Lists (Alternate command mode).....	9-23

9. Voice recognition

INFINITI VOICE RECOGNITION

INFINITI Voice Recognition allows hands-free operation of the navigation system and other systems equipped on this vehicle, in one of two modes, Standard Mode or Alternate Command Mode. Standard Mode allows the operation of Navigation, Phone, Audio, Information and Help.

The commands that are available are always shown on the display and announced by the system. To perform operations, simply follow the prompts given by the system. In Standard Mode, hands-free operation of Change map view, Route selection and Bluetooth Audio, etc. is not available through Voice Recognition.

Alternate Command Mode allows advanced operations. When this mode is active, an expanded list of commands can be spoken after pushing **<TALK** , and the voice command menu prompts are turned off. Note that in this mode the recognition success rate may be affected because the number of available commands and ways of speaking each command are increased. Otherwise, it is recommended that Alternate Command Mode be turned OFF and Standard Mode be used for the best

recognition performance.

 “Alternate command mode”
(page 9-9)

INFO:

- For U.S. customers, Standard Mode is selected by default. For Canadian customers, Alternate Command Mode is the default mode.
- To improve recognition success when Alternate Command Mode is active, try using the Speaker Adaptation function available in that mode.
 “Speaker adaptation” (page 9-15)
Otherwise, it is recommended that Alternate Command Mode be turned OFF and Standard Mode be used for the best recognition performance.
- For the voice commands for the audio, phone and other systems, refer to the vehicle Owner’s Manual. The following sections refer only to the navigation, phone and information systems.
- The voice recognition system cannot be operated when the retractable hard top is not closed (for G37 Convertible only).

STANDARD MODE

CONFIRMING HOW TO USE VOICE COMMANDS

When operating the voice recognition system for the first time or if help is preferred to use the system, the User Guide can be displayed.

It is possible to confirm how to use voice commands by accessing a simplified User Guide, which contains basic instructions and tutorials for several voice commands.

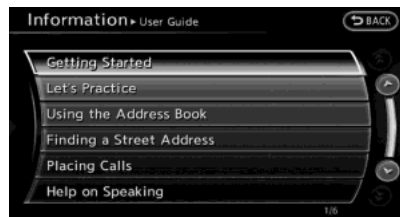

Basic operation

1. Push **<INFO>**.
2. Highlight [Others] and push **<ENTER>**.
3. Highlight [Voice Recognition] and push **<ENTER>**.

4. Highlight [User Guide] and push **<ENTER>**.
5. Highlight the preferred item and push **<ENTER>**.

Available items

- [Getting Started]:
Describes the basics of how to operate the voice recognition system.
- [Let's Practice]:
Mode for practice following the system voice.
- [Using the Address Book]:
Tutorial for entering a destination by the Address Book.
- [Finding a Street Address]:
Tutorial for entering a destination by street address.
- [Placing Calls]:
Tutorial for making a phone call by voice command operation. Refer to the vehicle Owner's Manual for details.
- [Help on Speaking]:
Displays useful tips regarding speaking for correct command recognition by the system.



INFO:

The Command List feature is only available when Alternate Command Mode is active.

Getting Started

Before using the voice recognition system for the first time, it is possible to confirm how to use commands by viewing the Getting Started section of the User Guide.

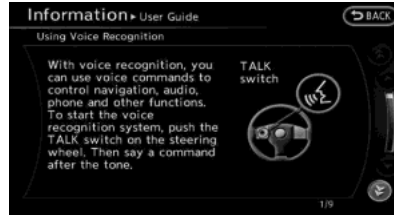

1. Highlight [Getting Started] and push **<ENTER>**.
2. To confirm the page, scroll the screen using INFINITI controller.

Practicing voice commands

Practice for using the voice recognition function can be performed by repeating a phone number after the system announces it.

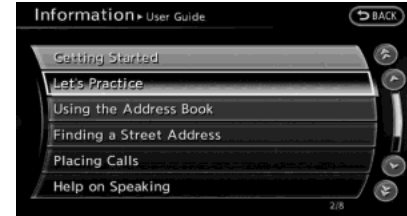

1. Highlight [Let's Practice] and push **<ENTER>**.
2. Practice voice commands in accordance with the audio guidance.

Tutorials on operation of voice recognition system

When highlighting [Using the Address Book], [Finding a Street Address] or [Placing Calls] and pushing **<ENTER>**, the system displays tutorials on how to perform these operations using voice recogni-

9. Voice recognition

tion.

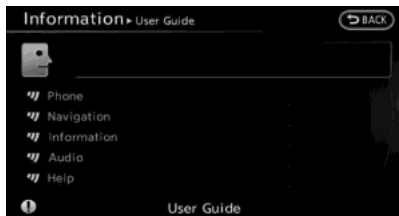

Useful tips for correct operation

It is possible to display useful speaking information that may help the system to accept a voice command correctly.

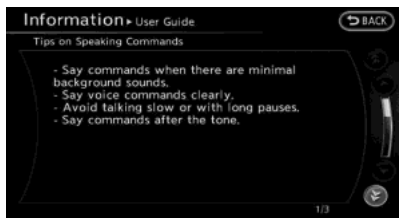

1. Highlight [Help on Speaking] and push **<ENTER>**.
2. To confirm the page, scroll the screen using the INFINITI controller.

USING VOICE RECOGNITION SYSTEM

Initialization

When the ignition switch is pushed to the ON position, Voice Recognition is initialized, which may take up to one minute. When completed, the system is ready to accept voice commands. If **<TALK >** is pushed before the initialization completes, the display will show the message: "System not ready".

BEFORE STARTING

To get the best recognition performance from Voice Recognition, observe the following items.

- The interior of the vehicle should be as quiet as possible. Close the windows to eliminate the surrounding noises (traffic noise and vibration sounds, etc.), which may prevent the system from correctly recognizing the voice commands.
- Wait until the tone sounds before speaking a command.
- Speak in a natural conversational voice without pausing between words.

- If the air conditioner is set to "Auto", the fan speed is automatically lowered so that voice commands can be recognized more easily.

GIVING VOICE COMMANDS

1. Push **<TALK >** located on the steering wheel.
2. A list of commands appears on the screen, and the system provides the voice menu prompt.
3. After the tone sounds and the icon on the screen changes from [] to [], speak a command.
4. Continue to follow the voice menu prompts and speak after the tone sounds until the preferred operation is completed.

Operating tips

- Speak a command after the tone.
- Commands that are available are always shown on the display and spoken through voice menu prompts. Commands other than those that are displayed are not accepted. Follow the prompts given by the system.

- If the command is not accepted, the system announces, “Please say again”. Repeat the command in a clear voice.
- Push **◀BACK** once to return to the previous screen.
- To cancel the command, push and hold **◀TALK**. The message, “Voice canceled” will be announced.

Voice Prompt Interrupt:

Push **◀TALK** to stop the voice prompt and give the command at once. Remember to wait for the tone before speaking.

How to speak numbers

INFINITI Voice Recognition requires a certain way to speak numbers when giving voice commands. Refer to the following examples.

General rule:

Only single digits 0 (zero) to 9 can be used. (For example, if speaking 500, “five zero zero” can be used, but “five hundred” cannot.)

Examples:

1-800-662-6200

“One eight zero zero six six two six two

zero zero”

Improving Recognition of Phone numbers: Recognition of phone numbers can be improved by speaking the phone number in 3 groups of numbers. For example, to call 800-662-6200, speak “Eight Zero Zero” first, and the system will then ask to speak the next three digits. Then, speak “Six Six Two”. After recognition, the system will then ask to speak the last 4 digits. Speak, “Six Two Zero Zero”. Using this method of phone digit entry can improve recognition performance.



INFO:

For best recognition, speak “zero” for the number “0” and “oh” for the letter “o”.

VOICE COMMAND EXAMPLES

To use the voice recognition function, speaking one command is sometimes sufficient, but at other times it is necessary to speak two or more commands. As examples, some additional basic operations that can be performed by voice commands are described here.

Example 1: Placing call to phone number 800-662-6200

1. Push **◀TALK** located on the steering wheel.
2. The system provides the voice menu prompt.
3. Speak “Phone”.



4. Speak “Dial Number”.

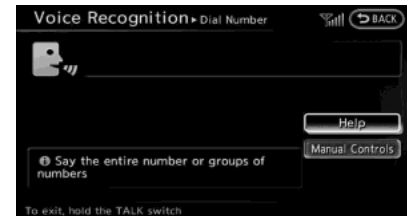

5. Speak “800”.

9. Voice recognition



6. The system announces, “Please say next three digits or dial, or say change number”. Speak “662”.



7. The system announces, “Please say last four digits or say change number”. Speak “6200”.

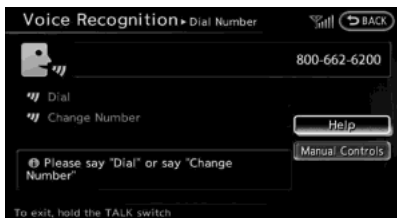

8. The system announces, “Dial or Change Number?”. Speak “Dial”.



9. The system makes a call to 800-662-6200.

INFO:

- Speaking “800-662-6200” (10 continuous digits) or “662-6200” (7 continuous digits) is acceptable, if the area code is not necessary. However the 3-3-4 digit grouping is recommended for improved recognition.
 “How to speak numbers” (page 9-14)

- The INFINITI voice recognition system is not limited to recognizing phone numbers of only 7 or 10 digits. To dial a number in a format other than the 3-3-4 digit grouping, use the “International Call” command.
- If “Change Number” is spoken during phone number entry, the system will automatically request that the number be repeated using the 3-3-4 format. In this case please speak the area code first and then follow the prompts.
- Do not add a “1” in front of the area code when speaking phone numbers.
- If the system does not recognize a voice command, please try repeating the command using a natural voice. Speaking too slowly or too loudly may further decrease recognition performance.

Example 2: Placing international call to phone number 011-81-111-222-333

1. Push **TALK**  located on the steering wheel.
2. The system provides the voice menu prompt.

3. Speak "Phone".



4. Speak "International Call".



5. Speak "01181111222333".



6. Speak "Dial".



7. The system makes a call to 011-81-111-222-333.

i INFO:

Any digit input format is available in the International Number input process.

Example 3: Setting destination by street address

1. Push **<TALK>** located on the steering wheel.
2. The system provides the voice menu prompt.
3. Speak "Navigation".



4. Speak "Address".

i INFO:

Push **<ENTER>** or touch [Help] to display the user guide screen.



5. Speak the name of the state, "California".

9. Voice recognition



6. Speak the name of the city, “Gardena”.

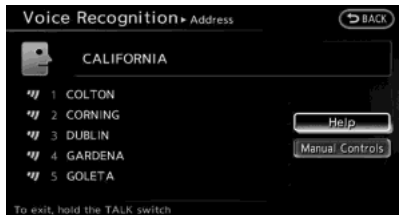

7. Voice feedback will be provided when the command is accepted, and the list of city names is displayed.

8. After the tone sounds and the icon on the screen changes again, speak “Four”.

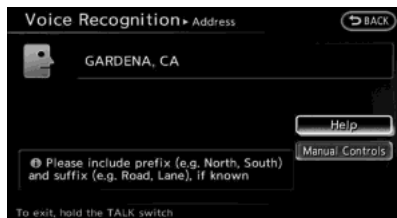

9. Speak the name of the street, “South Figueroa street”.

INFO:

- Only the official street names stored in the map database can be recognized by the system. To improve accuracy, speak the street name precisely and include Boulevard, Way, North, South, etc., if known. If unsure of the full name, speaking only part of the street name such as “Figueroa” is acceptable, but recognition accuracy may be reduced.
- To correct the entered city, street or house number, speak “Change City”, “Change Street” or “Change House Number”.

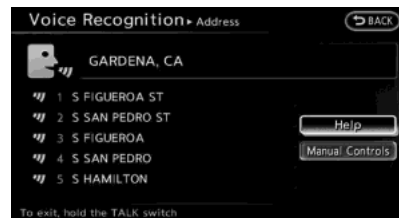

10. Voice feedback will be provided when the command is accepted, and the list of street names appears.

11. After the tone sounds and the icon on the screen changes again, speak “One”.

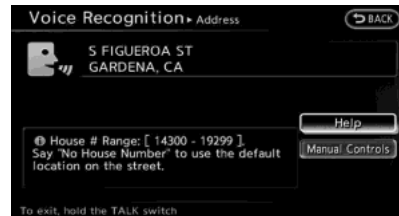

12. Speak the house number.

 “How to speak numbers”
(page 9-14)



INFO:

If the house number is unknown, speak “No house number”.

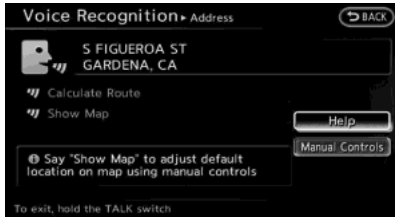

- To confirm the destination location on the map, speak “Show Map”. To calculate a route, speak “Calculate Route”.

ALTERNATE COMMAND MODE

The following section is applicable when Alternate Command Mode is active.

- “Setting alternate command mode” (page 9-14)

When Alternate Command Mode is active, an expanded list of commands can be used after pushing **<TALK>**. In this mode, available commands are not fully shown on the display or prompted. Review the expanded command list, available when this mode is active. See examples of Alternate Command Mode screens. Otherwise, it is recommended that Alternate Command Mode be turned OFF and Standard Mode be used for the best recognition performance.

- “Confirming voice commands” (page 9-10)

DISPLAYING HOW TO OPERATE VOICE RECOGNITION SYSTEM

When operating the voice recognition system for the first time or if help is preferred to use the system, the Command List (available only in Alternate Command Mode) or the User Guide are available.

Basic operation

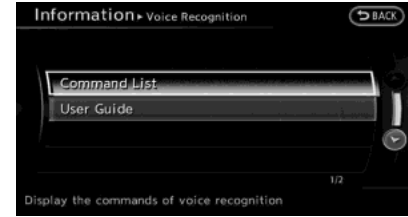

- Push **<INFO>**.
- Highlight [Others] and push **<ENTER>**.
- Highlight [Voice Recognition] and push **<ENTER>**.
- Highlight the preferred item and push **<ENTER>**.

Available items

- [Command List]:
A list of voice commands that the system can accept is displayed.
- [User Guide]:
A simplified operation manual of the voice recognition system can be displayed and how to use the voice commands can be confirmed.

9. Voice recognition



INFO:

The Command List feature is only available when Alternate Command Mode is active.

Confirming voice commands

When controlling the system by voice commands for the first time or if an appropriate voice command is unknown, confirm using the voice command lists.

The following information describes how to display the navigation command list and the help list. For information about the operations of other functions, refer to the vehicle Owner's Manual.

Example: Displaying the navigation command list

1. Push **<INFO>**.
2. Highlight [Others] and push **<ENTER>**.
3. Highlight [Voice Recognition] and push **<ENTER>**.



4. Highlight [Command List] and push **<ENTER>**.



5. Highlight the preferred item and push **<ENTER>**.

“Command Lists (Alternate command mode)” (page 9-23)

Available items

- Phone Commands
- Navigation Commands

- Information Commands
- Audio Commands
- Help Commands

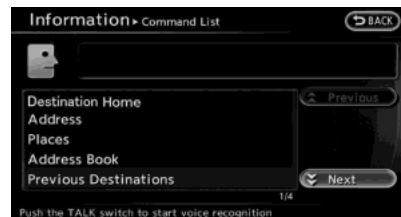

6. To confirm the list, scroll the screen using the INFINITI controller.
7. Push **<BACK>** to return to the previous screen.

CONFIRMING HOW TO USE VOICE COMMANDS

It is possible to confirm how to use voice commands by accessing a simplified User Guide, which contains basic instructions and tutorials for several voice commands.

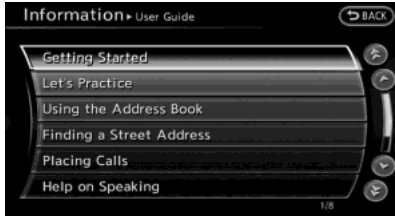

Basic operation

1. Push **<INFO>**.
2. Highlight [Others] and push **<ENTER>**.
3. Highlight [Voice Recognition] and push **<ENTER>**.
4. Highlight [User Guide] and push **<ENTER>**.
5. Highlight the preferred item and push **<ENTER>**.

Available items

- [Getting Started]:
Describes the basics of how to operate the voice recognition system.
- [Let's Practice]:
Mode for practice following the system voice.

- [Using the Address Book]:
Tutorial for setting a destination by the Address Book.
- [Finding a Street Address]:
Tutorial for entering a destination by street address.
- [Placing Calls]:
Tutorial for marking a phone call by voice command operation.
- [Help on Speaking]:
Displays the useful tips of speaking for correct command recognition by the system.
- [Voice Recognition Settings]:
Describes the available voice recognition settings.
- [Adapting the System to Your Voice]:
Tutorial adapting the system to the user's voice.

Getting Started

Before using the voice recognition system for the first time, it is possible to confirm how to use commands by viewing the Getting Started section of the User Guide.

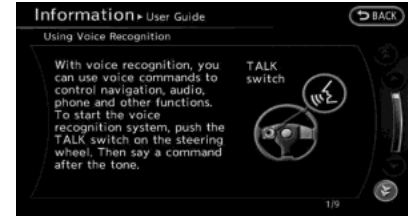

1. Highlight [Getting Started] and push **<ENTER>**.
2. To confirm the page, scroll the screen using the INFINITI controller.

Practicing voice commands

Practice for using the voice recognition function can be performed by repeating a phrase after the system announces it.

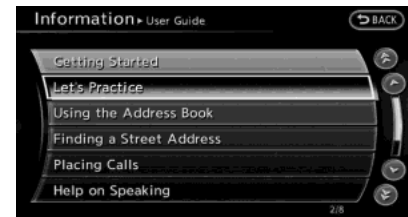

1. Highlight [Let's Practice] and push **<ENTER>**.

9. Voice recognition

2. Practice voice commands in accordance with the audio guidance.

Tutorials on operation of voice recognition system

When highlighting [Using the Address Book], [Finding a Street Address] or [Placing Calls] and pushing **<ENTER>**, the system displays tutorials on how to perform these operations using voice recognition.

Example: With [Using the Address Book] highlighted and **<ENTER>** pushed.

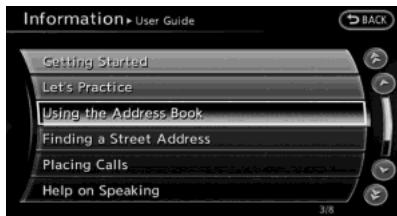

1. Highlight [Using the Address Book] and push **<ENTER>**. The tutorial starts.

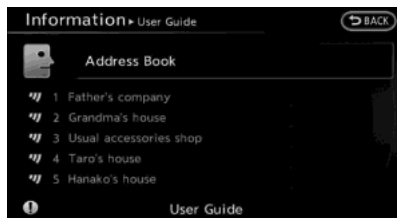

2. The voice guide demonstrates how to speak when giving commands.
3. When the tutorial is completed, the system automatically switches to the Menu screen.

Useful tips for correct operation

It is possible to display useful speaking tips that may help the system to accept a voice command correctly.

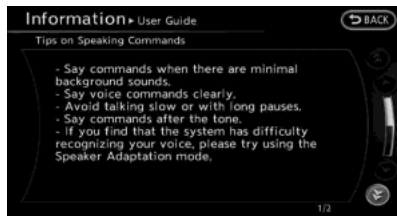

1. Highlight [Help on Speaking] and push **<ENTER>**.
2. To confirm the page, scroll the screen using the INFINITI controller.

Voice recognition settings

The settings for easy operation of the voice recognition system are displayed.

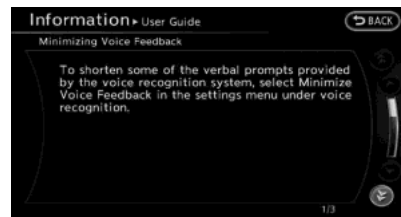

1. Highlight [Voice Recognition Settings] and push **<ENTER>**.
2. To confirm the page, scroll the screen using the INFINITI controller.

Adapting Voice Recognition System to Your Voice

The voice recognition system is equipped with a learning function to adapt to the user's voice for better recognition. It is possible to confirm how to operate the learning function through this tutorial.

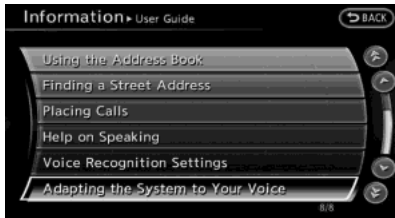

1. Highlight [Adapting the System to Your Voice] and push **<ENTER>**. The tutorial starts.

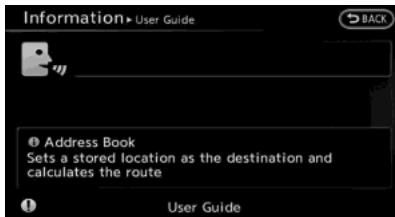

2. The voice guide demonstrates the steps that have to be performed.
3. When the tutorial is completed, the system automatically switches to the Menu screen.

USING VOICE RECOGNITION SYSTEM

Initialization

When the ignition switch is pushed to the ON position, Voice Recognition is initialized, which may take up to one minute. When completed, the system is ready to accept voice commands. If **<TALK <TALK>** is pushed before the initialization completes, the display will show the message: "System not ready".



BEFORE STARTING

To get the best recognition performance out of Voice Recognition, observe the following:

- The interior of the vehicle should be as quiet as possible. Close the windows to eliminate the surrounding noises (traffic noise and vibration sounds, etc.), which may prevent the system from correctly recognizing the voice commands.
- Wait until the tone sounds before speaking a command.
- Speak in a natural conversational voice without pausing between words.

- If the air conditioner is set to "Auto", the fan speed is automatically lowered so that voice commands can be recognized more easily.
- The voice recognition system cannot be operated when the retractable hard top is not closed (for G37 Convertible only).

GIVING VOICE COMMANDS

1. Push **<TALK <TALK>** located on the steering wheel.
2. A list of commands appears on the screen, and the system announces, "Please say a command".
3. After the tone sounds and the icon on the screen changes from [] to [], speak a command.

Operating tips

- If the command is not recognized, the system announces, "Please say again". Repeat the command in a clear voice.
- Push **<BACK>** once to return to the previous screen.
- To cancel the command, push and hold **<TALK <TALK>**. The message, "Voice canceled" will be announced.

9. Voice recognition

Voice Prompt Interrupt:

Push **<TALK**  to stop the voice prompt and give the command at once. Remember to wait for the tone before speaking.

How to speak numbers

INFINITI Voice Recognition requires a certain way to speak numbers when giving voice commands. Refer to the following examples.

General rule:

Only single digits 0 (zero) to 9 can be used. For example, to speak 500, “five zero zero” can be used, but “five hundred” cannot.

Examples:

1-800-662-6200

“One eight zero zero six six two six two zero zero”

Improving Recognition of Phone numbers:

Recognition of phone numbers can be improved by speaking the phone number in 3 groups of numbers. For example, to call 800-662-6200, speak “Eight Zero Zero” first, and the system will then ask to speak the next three digits. Then, speak “Six Six Two”. After recognition, the system will then ask to speak the last 4

digits. Speak, “Six Two Zero Zero”. Using this method of phone digit entry can improve recognition performance.



For best recognition, speak “zero” for the number “0” and “oh” for the letter “o”.

SYSTEM FEEDBACK ANNOUNCEMENT MODES

It is possible to select two modes, long or short, for the announcement by the system.

How to set

1. Push **<SETTING>**.
2. Highlight [Others] and push **<ENTER>**.
3. Highlight [Voice Recognition] and push **<ENTER>**.

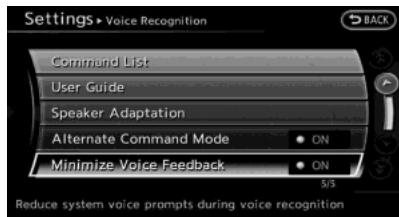

4. Highlight [Minimize Voice Feedback] and push **<ENTER>**. The indicator illuminates, and the system announcement mode switches to the short mode.
5. Push **<BACK>** to return to the previous screen. Push **<MAP>** to return to the current location map screen.

SETTING ALTERNATE COMMAND MODE

This mode enables the operation of the display and audio through Voice Recognition. When this mode is active, an expanded list of commands can be spoken after pushing **<TALK** , and the voice command menu prompts are turned off. Note that in this mode the recognition success rate may be affected because the number of available commands and ways of speaking each command are increased.

This mode can be turned on or off.

How to set

1. Push **<SETTING>**.
2. Highlight [Others] and push **<ENTER>**.
3. Highlight [Voice Recognition] and push **<ENTER>**.

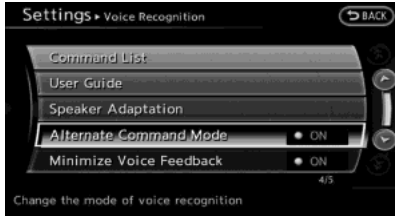

4. Highlight [Alternate Command Mode] and push **<ENTER>**. A confirmation message is displayed. Highlight [Yes] and push **<ENTER>**. The indicator illuminates, and Alternate Command Mode switches to ON.
5. Push **<BACK>** to return to the previous screen. Push **<MAP>** to return to the current location map screen.

SPEAKER ADAPTATION

The voice recognition system has a function to learn the user's voice for better voice recognition performance.

The system can memorize the voices of up to three persons.

Having system learn user's voice

1. Push **<SETTING>**.
2. Highlight [Others] and push **<ENTER>**.
3. Highlight [Voice Recognition] and push **<ENTER>**.

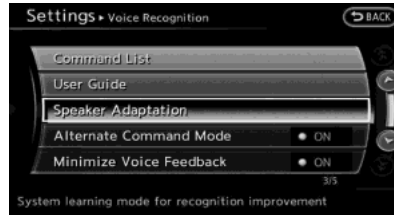

4. Highlight [Speaker Adaptation] and push **<ENTER>**.

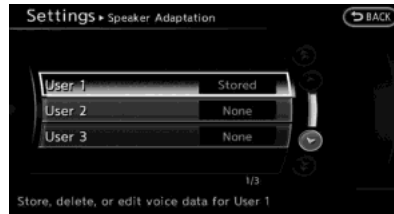

5. Highlight the user whose voice is memorized by the system, and push **<ENTER>**.



6. Highlight [Start Speaker Adaptation Learning] and push **<ENTER>**.

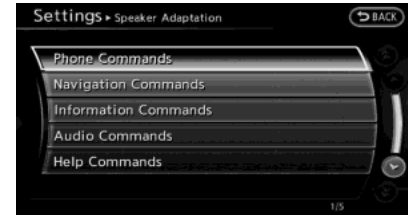

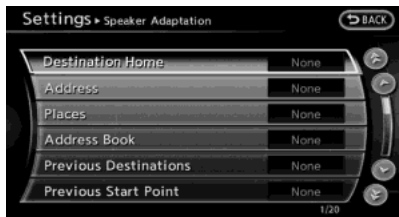

7. Highlight the voice command category to be learned by the system, and push **<ENTER>**. The voice command category list is displayed.

9. Voice recognition

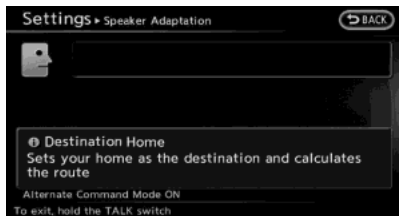

8. Highlight the voice command to be learned by the system, and push **<ENTER>**. The voice recognition system starts.



9. The system announces, "Please say a command".
10. After the tone sounds and the icon on the screen changes from [] to [], speak a command.

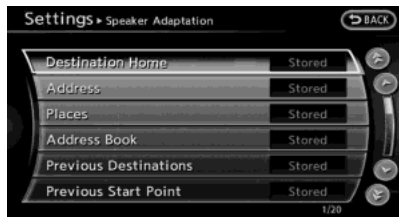

11. When the system has recognized the voice command, the voice of the user is learned. Push **<BACK>** once to return to the previous screen.

INFO:

With [Continuous Learning] set to on, the system does not go back to the command list screen, allowing to continue voice command learning by the system.

12. If the system has learned the command correctly, "None" will change to "Stored".

Editing registered items

It is possible to edit user names and select learning function settings.

1. Push **<SETTING>**.

2. Highlight [Others] and push **<ENTER>**.
3. Highlight [Voice Recognition] and push **<ENTER>**.

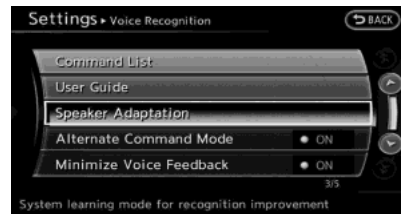

4. Highlight [Speaker Adaptation] and push **<ENTER>**.

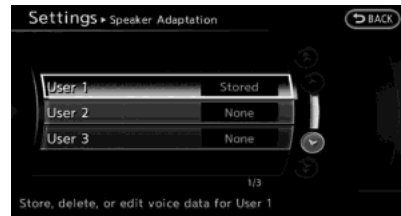

5. Highlight a user to edit, and push **<ENTER>**.

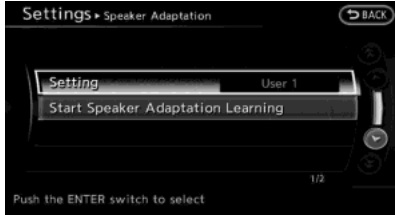

6. Highlight [Setting] and push **<ENTER>**.

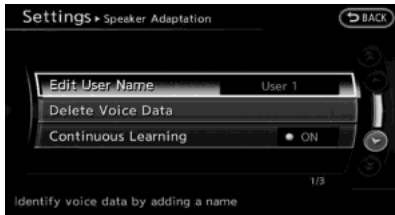

7. Highlight an item to edit, and push **<ENTER>**.

Setting items



- [Edit User Name]:
Edit the user name.
- [Delete Voice Data]:
Reset the user voice that the voice recognition system has learned.

- [Continuous Learning]:
Have the system learn the voice commands of the user in succession, without selecting commands one by one.

VOICE COMMAND EXAMPLES

To use the voice recognition function, speaking one command is sometimes sufficient, but at other times it is necessary to speak two or more commands. As examples, some additional basic operations by voice commands are described here.

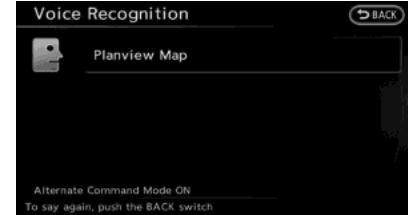

Example 1: Switching map to 2D (Plan View) mode

1. Push **<TALK**  located on the steering wheel.
2. The system announces, "Please say a command".
3. After the tone sounds and the icon on the screen changes from [] to [], speak "Plan View Map".



4. Voice feedback will be provided when the command is accepted, and the map is displayed in 2D (Plan View).

Example 2: Setting destination using places list

1. Push **<TALK**  located on the steering wheel.
2. The system announces, "Please say a command".
3. After the tone sounds and the icon on the screen changes from [] to [], speak "Places".

9. Voice recognition



4. If a route is already set, choose “Near Current Location”, “Along Route” or “Near Destination”.
5. After the tone sounds and the icon on the screen changes again, speak “Along Route”.



6. Voice feedback will be provided when the command is accepted, and the list of places of interest categories appears.

7. After the tone sounds and the icon on the screen changes again, speak “Two”.



8. Voice feedback will be provided when the command is accepted, and the list of places of interest in the category specified in the previous step appears.
9. After the tone sounds and the icon on the screen changes again, speak “One”.

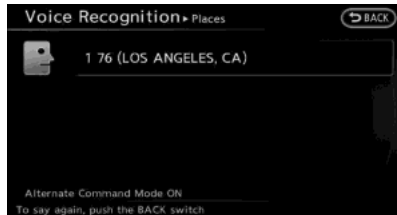

10. Voice feedback will be provided when the command is accepted, and the system starts calculating a route to the selected facility.

Example 3: Setting destination by street address

1. Push **TALK** located on the steering wheel.
2. The system announces, “Please say a command”.
3. Speak “Address”.



4. Speak the name of the state, “California”.

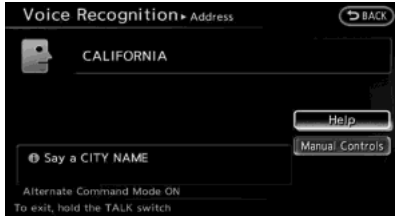

5. Speak the name of the city, “Gardena”.

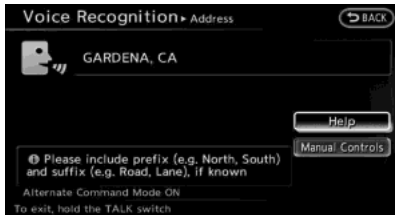

6. Speak the name of the street, “South Figueroa street”.



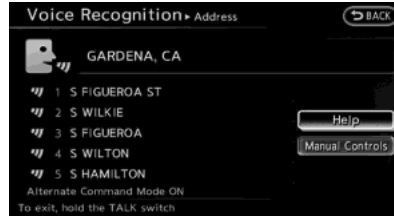

INFO:

Speak the street name precisely including boulevard, way, north, south, etc. In Alternate Command Mode, the system does not recognize abbreviated names when they are spoken. In this case, the system does not accept “Figueroa street” or “Figueroa”.

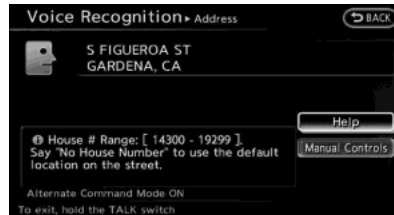

7. Voice feedback will be provided when the command is accepted, and the list of street names appears.
8. After the tone sounds and the icon on the screen changes again, speak “One”.



9. Speak the house number.
 “How to speak numbers”
 (page 9-14)



INFO:

If the house number is unknown, speak “No house number”.

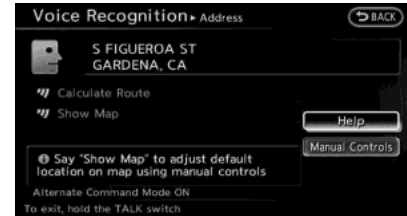

10. To confirm the destination location on the map, speak “Show Map”. To calculate a route, speak “Calculate Route”.

9. Voice recognition

COMMAND LISTS (Standard mode)

Category	Command	Action
	Call (Optional)	Makes a call to a contact that is stored in either phonebook. Please say "Call" followed by a stored name.
	Phone	Operates the Phone function.
	Navigation	Operates the Navigation function.
	Information	Displays the Vehicle Information function.
	Audio	Operates the Audio function.
	Help	Displays the User Guide.

Navigation	Command	Action
	Destination Home	Sets a route to the home location that is stored in the Address book.
	Address	Searches for a location by the street address specified, and sets a route (for continental U.S. and Canada only).
	Places	Sets a route to a facility near the current vehicle location.
	Address Book	Searches for information stored in the Address Book.
	Previous Destinations	Sets a route to a previous destination.

9. Voice recognition

Phone	Command		Action
	Dial Number		Makes a call to a spoken phone number up to 10 digits.
	Quick Dial		Makes a call to a contact that is stored in the Quick Dial.
	Phonebook		Makes a call to a phone number stored in a mobile phone.
	Call History	Incoming Calls	Makes a call to an incoming call number.
		Outgoing Calls	Makes a call to a dialed number.
		Missed Calls	Makes a call to a missed calls number.
International Call		Makes an international call by allowing more than 10 digits to be spoken.	

Information	Command		Action
	Fuel Economy		Displays fuel economy information.
	Trip Computer (if so equipped)		Displays trip information.
	Maintenance		Displays maintenance information.
	Where am I?		Displays the current location.
	Traffic Information		Turns the traffic information system on and off.

Audio	Command		Action
	AM		Turns to the AM band, selecting the station last played.
	FM		Turns to the FM band, selecting the station last played.
	XM		Turns to the SiriusXM Satellite Radio band, selecting the channel last played.
	CD		Starts to play a CD.

9. Voice recognition

General	Command	Action
	Go back	Corrects the last recognition result to return to the previous screen.
	Exit	Cancels Voice Recognition.



INFO:

Refer to the vehicle Owner's Manual for the operations related to phone, information and audio.

COMMAND LISTS (Alternate command mode)



INFO:

The words in *italics* are variable.

Navigation Commands	Command	Action
	Destination Home	Sets a route to your home location.
	Address	Sets a route to the street address that you specify (for continental U.S. and Canada only).
	Places	Sets a route to a facility near the current vehicle location.
	Address Book	Sets a route to a location stored in the Address Book.
	Previous Destinations	Sets a route to a previously entered destination.
	Previous Start Point	Sets a route to the previous starting point.
	Minimize Freeway Route	Sets the route search condition to minimize the usage of freeways.
	Fastest Route	Sets the route search condition to find the fastest time.
	Shortest Route	Sets the route search condition to find the shortest distance.
	Cancel Route	Stops the current route but can be resumed by using <ROUTE>.
	Delete Destination	Deletes the entire route (destination and waypoints).
	Birdview Map	Displays the map in Birdview™ (3D).
	Planview Map	Displays the map in Plan View (2D).
	North Up	Locks the map to make North always point up.
	Heading Up	Locks the vehicle indicator to make it always point up.
	Zoom In <1 to 13>	Increases the magnification of the map by the number of steps specified.

9. Voice recognition

Navigation Com- mands	Command	Action
	Zoom Out <i><1 to 13></i>	Decreases the magnification of the map by the number of steps specified.
	Voice Guidance <i>On/Off</i>	Turns the navigation guidance on and off.
	Guidance Voice Repeat	Repeats the current navigation voice guidance.

Information Com- mands	Command	Action
	Fuel Economy	Displays fuel economy information.
	Tire Pressure (if so equipped)	Displays tire pressure information.
	Trip Computer (if so equipped)	Displays trip information.
	Maintenance	Displays maintenance information.
	Where am I?	Displays the current location.
	Traffic Information	Turns the traffic information system on and off.
	Weather Information	Displays weather information (for continental U.S. and Canada only).
	Weather Map	Displays the weather map (for continental U.S. and Canada only).

9. Voice recognition

Vehicle Phone Commands	Command		Action
	Dial Number		Makes a call to a spoken phone number.
	Quick Dial		Makes a call to a contact that is stored in the Quick Dial.
	Phonebook		Makes a call to a contact that is stored in a mobile phone.
	Call History	Incoming Calls	Makes a call to an incoming call number.
		Outgoing Calls	Makes a call to a dialed number.
		Missed Calls	Makes a call to a missed calls number.
	International Call		Makes an international call by allowing more than 10 digits to be spoken.
Call <i><name></i>		Makes a call to a contact that is stored in either Quick Dial or Phonebook. Please say "Call" followed by a stored name.	

Audio Commands	Command		Action
	CD		Starts to play a CD.
	FM		Turns to the FM band, selecting the station last played.
	AM		Turns to the AM band, selecting the station last played.
	XM		Turns to the SiriusXM Satellite Radio band, selecting the channel last played.
	USB		Turns on the USB memory.
	Bluetooth Audio		Turns on the Bluetooth audio player.
	AUX (if so equipped)		Turns on the AUX.

General Commands	Command		Action
	Go back		Corrects the last recognition result to return to the previous screen.
	Exit		Cancels Voice Recognition.

9. Voice recognition

Help Commands	Command	Action
	Command List	Displays the category list of commands.
	Navigation Commands	Displays the navigation command list.
	Phone Commands	Displays the phone command list.
	Audio Commands	Displays the audio command list.
	Information Commands	Displays the information command list.
	Help Commands	Displays the help command list.
	User Guide	Displays the User Guide
	Speaker Adaptation	The system memorizes the voices of up to three persons for better voice recognition performance.



INFO:

Refer to the vehicle Owner's Manual for the operations related to phone, information and audio.

10 General system information

Features of this navigation system	10-2	Route calculation	10-8
Route guidance	10-2	Route guidance.....	10-10
Places of interest (PLACES) directory	10-2	Basics of voice guidance	10-10
Address book.....	10-2	Directions provided and distances to guide points.....	10-10
Avoid area	10-2	Repeating voice guidance	10-13
NavTraffic information	10-2	Notes on voice guidance.....	10-13
Automatic reroute	10-3	Notes on NavTraffic information	10-14
Detour.....	10-3	Notes on NavWeatherXM information	10-15
Birdview™	10-3	Map data.....	10-16
Voice guidance.....	10-3	How to order map data updates	10-16
Current vehicle location.....	10-4	About map icons	10-16
Display of current vehicle location.....	10-4	About map data.....	10-16
What is GPS (Global Positioning System)?	10-4	End-user terms.....	10-18
Incorrect display of vehicle position	10-5	How to handle display	10-21
Detailed Map Coverage Areas (MCA) for navigation system.....	10-7	Characteristics of liquid crystal display.....	10-21
When gray road is displayed on map	10-8	Maintenance of display.....	10-21

10. General system information

FEATURES OF THIS NAVIGATION SYSTEM

ROUTE GUIDANCE

The main features of the INFINITI Navigation System are visual guidance and voice guidance in selected map coverage areas. Utilizing a network of GPS (Global Positioning System) satellites, the INFINITI Navigation System tracks the location on the map and navigates to a preferred location.

Once the destination is set in a map coverage area, the INFINITI Navigation System will calculate a route from the current location to the destination. The real-time map display and turn-by-turn voice guidance leads the driver along the route. These features can be especially helpful when driving to unfamiliar locations.

The system may be unable to set a destination and/or calculate a route when the destination is outside the map coverage area. Additionally, voice guidance may not be available if the destination is outside the map coverage area. For more information on how to set a destination, refer to section 4.

PLACES OF INTEREST (PLACES) DIRECTORY

The INFINITI Navigation System offers an extensive places of interest (Places) directory in map coverage areas. This directory includes a wide variety of destinations ranging from gas stations, ATMs, and restaurants to casinos, ski resorts, shopping centers and businesses. A point of interest can be searched by category, name or phone number. After selecting a destination, the INFINITI Navigation System will calculate a route to that destination.

The Places directory has many uses. For example, the directory can be sorted by the various types of restaurants near the current location. If an ATM or gas station is needed, the INFINITI Navigation System can navigate to the closest preferred location.

For more information on how to use the Places directory, refer to section 4.

ADDRESS BOOK

The Address Book can store up to 300 locations from map coverage areas into a personal directory. This is especially useful for frequently visited locations, such as clients, relatives and friends. The Address

Book function allows easy access to frequently visited locations when setting them as your destination.

For more information on how to use the Address Book, refer to section 6.

AVOID AREA

The Avoid Area function sets areas or freeways that the INFINITI Navigation System does not include in the suggested route when calculating routes. For example, if a freeway or area that is always congested with traffic.

For more information on the Avoid Area function, refer to section 6.

NavTraffic INFORMATION

When available, the NavTraffic Information broadcast may help to avoid delays due to traffic incidents. Traffic jams, roadwork, closed roads around the current location, etc. are represented graphically on the map by icons depicting the nature of the event. Incidents on the route are automatically brought to the attention when they are approached.

The NavTraffic Information feature, via the guidance mode, may help to detour around traffic problems. For more information on

the NavTraffic Information feature, refer to section 5.

AUTOMATIC REROUTE

When detecting a deviation from the suggested route, the INFINITI Navigation System will automatically recalculate a new route to the destination.

For more information on the Automatic reroute function, refer to section 5.

DETOUR

To make a detour due to traffic conditions, the Detour function calculates an alternative route. The INFINITI Navigation System can calculate a route using secondary roads that will return to primary roads after a specified number of miles.

For more information on the Detour function, refer to section 5.

Birdview™

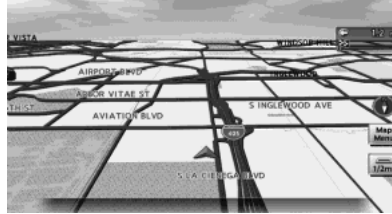

Two map types, the 2D (Plan View) map and Birdview™ (3D) map, are available in the INFINITI Navigation System. Birdview™ map displays the map from an elevated perspective. In Birdview™ map, it is easy to recognize an image of the route because it provides a panoramic view over a long distance.

For more information on Birdview™ map, refer to section 3.

VOICE GUIDANCE



Route guidance is provided through voice and visual instructions. Voice guidance announces the appropriate directions when approaching an intersection to turn. For more information on voice guidance, refer to section 5.

10. General system information

CURRENT VEHICLE LOCATION

DISPLAY OF CURRENT VEHICLE LOCATION

This navigation system combines the data obtained from the vehicle (by gyro sensor) and from GPS (Global Positioning System) satellites to calculate the current location of the vehicle. This position is then displayed throughout route guidance to a destination.

WHAT IS GPS (Global Positioning System)?

GPS is a position detecting system that uses satellites deployed by the U.S. government. This navigation system receives radio signals from three or more different satellites that orbit 13,049 miles (21,000 km) above the earth in space, and detects the position of the vehicle by utilizing the principle of triangulation.

Positioning adjustment

When the system judges that the vehicle position information is not accurate based on vehicle speed and gyro sensor data calculations, the system will automatically adjust the position of the vehicle icon

using GPS signals.

Receiving signals from GPS satellites

The reception of GPS signals can be weak, depending on the environment. Vehicles in the following areas/environments may not receive GPS signals (indicator color: gray).



- Inside tunnels or parking garages



- Areas with numerous tall buildings

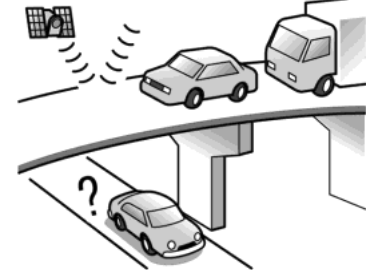

- Under multi-layered highways



- Under many large trees

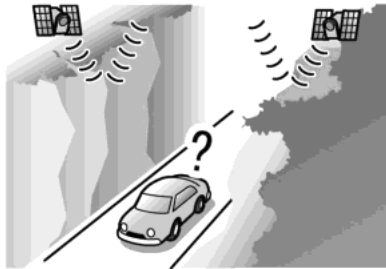

- In a canyon



INFO:

The GPS antenna is located on the instrument panel inside the vehicle. Do not place any objects, especially mobile phones or transceivers, on the instrument panel. Because the strength of the GPS signal is approximately one billionth of that of TV waves, phones and transceivers will affect or may totally disrupt the signal.

Display of GPS information

GPS information can be displayed.

 “Viewing GPS current location information” (page 7-32)



NOTE:

Route guidance provided by the navigation system does not take carpool lane driving into consideration, especially when carpool lanes are separated from other road lanes.

INCORRECT DISPLAY OF VEHICLE POSITION

The following cases may affect the display accuracy of the vehicle's position or traveling direction. The accuracy will return to normal if the driving conditions return to normal.



- When there is a similar road nearby.

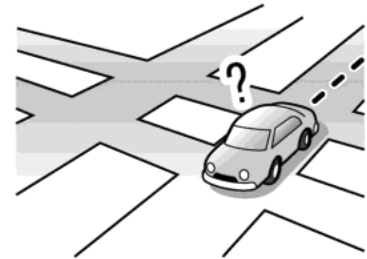

- When the vehicle is traveling in an area with a grid pattern road system.

10. General system information

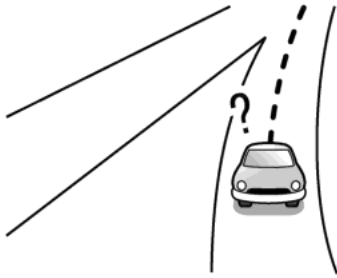

- When the vehicle is passing through a large Y-shaped intersection/junction.



- When the vehicle is traveling on a road with repeating S-shaped curves.



- When the vehicle is on a snow-covered or unpaved road.



- When the vehicle is traveling on a continuous, slowly curving road.



- When the vehicle is on a loop bridge.

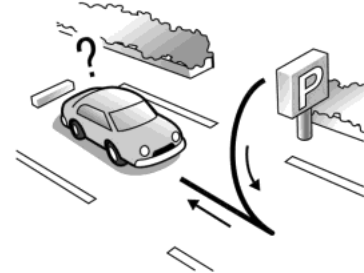

- When repeatedly turning left or right, or driving in zigzags.

10. General system information

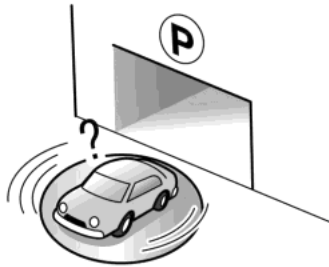

- When the vehicle is rotated on a parking lot turntable while the ignition switch is off.

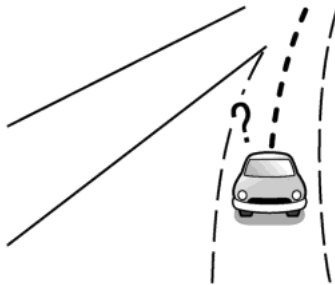

- When driving on a road not displayed on the map screen or a road that has been changed due to additional construction or other reasons.



- When the GPS positioning accuracy is low.

INFO:

- The vehicle icon may be misaligned when starting the vehicle just after starting the engine or the hybrid system.
- The vehicle icon may also be misaligned if different sized tires or tire chains are installed.
- The system has a function that automatically corrects the vehicle icon position when it is misaligned from the actual position.
- Vehicle position correction by GPS may not function when the vehicle is stopped.

- If the vehicle icon position does not return to normal even after driving for a while, correct the vehicle icon position manually.
 “Adjusting current vehicle location” (page 8-9)

DETAILED MAP COVERAGE AREAS (MCA) FOR NAVIGATION SYSTEM

This system is designed to help guiding to the destination, and it also performs other functions as outlined in this manual. However, the system must be used safely and properly. Information concerning road conditions, traffic signs and the availability of services may not always be up-to-date. The system is not a substitute for safe, proper and legal driving. Map data covers select metropolitan areas in the United States and Canada.

Map data includes two types of areas: “Detailed coverage areas” providing all detailed road data and other areas showing “Main roads only”.

NOTE:

Detailed map data is not available in many areas and is generally limited to select major metropolitan areas.

10. General system information

WHEN GRAY ROAD IS DISPLAYED ON MAP

- When you are driving on a road displayed in gray after the vehicle has deviated from the suggested route during route guidance, automatic rerouting may not start immediately.
- The navigation system does not provide route guidance for roads displayed in dark green. Therefore, if the destination is set on a road displayed in dark green, the enlarged map display will return to the ordinary map screen at some point on a suggested route that is near the destination. Also, voice guidance will stop at some point on a suggested route that is near the destination.
- Places information and street names near roads displayed in gray may not be contained in the map data.

ROUTE CALCULATION

- There may be cases that carpool lanes are included on a suggested route when the automatic rerouting function is activated, even if the “Use Time Restricted Roads” is turned off.
 “Setting conditions for route calculation” (page 5-25)
- The navigation system does not provide route guidance for roads displayed in dark green.
- If the destination is set on a dark green road, the enlarged map display will switch to the ordinary map screen at some point and suggest a route that is near the destination. The distance and direction to the endpoint of the suggested route will be displayed in the lower right corner of the screen. Also, at this time, voice guidance will announce, “The route to the destination includes roads through incomplete map areas. Voice guidance will not be provided in these areas”.

When approaching the endpoint of the suggested route, voice guidance will announce, “Entering the road with incomplete map data. Use the direction

arrow and distance information to proceed to your destination.”

To reach the destination, refer to the map screen. Always follow actual roads and regulations and drive safely.

- The suggested route may not be the shortest, nor are other circumstances such as traffic jams considered.
- Because of the inevitable difference in road conditions and circumstances between the time you use this system and the time the information was produced for the map data, there may be discrepancies in roads and regulations. In such cases, follow the actual information available.
- During route calculation, the map will not scroll, however the vehicle icon will move with the actual vehicle’s movement.
- During route calculation, buttons such as **<ZOOM OUT>/<ZOOM IN>** (if so equipped), **<MAP>**, **<DEST>** and the INFINITI controller will be disabled.
- In some cases, after the calculation is complete, the calculated route may not be immediately displayed.

- Waypoints that have been passed will be disregarded by rerouting calculation.
- If you scroll the map while the suggested route is being drawn, it may take more time to finish drawing.
- If waypoints are set, the system calculates multiple routes between waypoints simultaneously, and the following may result.
 - If one section between waypoints cannot be calculated, none of the route will be displayed.
 - The route may not connect completely at some waypoints.
 - The route may require a U-turn close to some waypoints.
- Route calculation may not be completed in the following cases.
 - If there is no main road within a range of 1.5 miles (2.5 km) from the vehicle, a message saying so will appear on the screen. Try recalculating when the vehicle is closer to a main road.
 - If there is no main road within a range of 1.5 miles (2.5 km) from the destination or waypoint, a message saying so will appear on the screen. Try setting the location closer to a main road.
- If the vehicle is too close to the destination or if there are no roads to the destination, a message saying so will appear on the screen.
- If it is impossible to reach the destination or waypoints because of traffic regulations, etc.
- If the only route to reach the destination or waypoints is extremely complicated.
- If the destination, current vehicle position or waypoint is within the “Avoid Area”.
- If a part of the route is included in the “Avoid Area”.
- The following may occur when the route is displayed.
 - If you calculate a route on a main road, the starting point of the route may not exactly match the current vehicle location.
 - The endpoint of the route may not exactly match the destination.
 - If you calculate a route on a main road, the system may display a route from another main road. This may be because the position of the vehicle icon is not accurate. In this case, park the vehicle in a safe location and reset the vehicle icon, or continue driving to see if the position of the vehicle icon is automatically adjusted before recalculating the route.
- There are cases in which the system shows an indirect route to reach the destination or waypoints, if you set them from stored or facility information. In order to correct this, you must be careful about the traffic direction, especially when lanes with different travel directions are shown separately, such as interchanges and service areas.
- This system makes no distinction between limited traffic control and total control (blockage). It may show an indirect route even if the road is usable.
- Even if the freeway preference is set to OFF, a route that uses the freeway may be suggested.
- Even if the ferry preference is set to OFF, a route that uses a ferry line may be suggested.

10. General system information

- Ferry lines, excluding those that are only for pedestrians, bicycles and motorcycles, are stored in this system. Take into consideration the travel time required and operational condition before deciding whether to use them or not.

ROUTE GUIDANCE

INFO:

The system will only announce street names when the system language is set to English. Street names are not announced when the system is set to Français (French).

BASICS OF VOICE GUIDANCE

Voice guidance announces which direction to turn when approaching an intersection in which a turn is necessary.

NOTE:

- There may be some cases in which voice guidance and actual road conditions do not correspond. This may occur because of discrepancies between the actual road and the information on the map data, or it is due to the vehicle's speed.
- In case voice guidance does not correspond to the actual road conditions, follow the information obtained from traffic signs or notices on the road.
- Route guidance provided by the navigation system does not take carpool lane driving into consideration, especially when carpool

lanes are separated from other road lanes.

DIRECTIONS PROVIDED AND DISTANCES TO GUIDE POINTS

Directions will differ, depending on the road type.

INFO:

Distances may vary, depending on the vehicle speed.

Notification of intersection on ordinary road

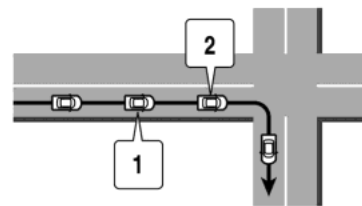

1. "In about one quarter mile (400 meters), right (left) turn."
2. "Right (left) turn ahead."

Notification of consecutive intersections on ordinary roads

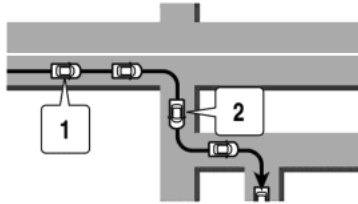

When the road has three or more consecutive intersections ahead, voice guidance will announce the following.

1. "In about one quarter mile (400 meters), right (left) turn, then in about one quarter mile (100 meters) left (right) turn."
2. "Left (right) turn ahead, then in about one quarter mile (100 meters) right (left) turn."

Notification of freeway entrance

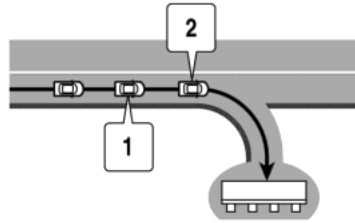

1. "In about one quarter mile (400 meters) freeway entrance on your right onto (road number and direction)."
2. "Freeway entrance on your right onto (road number and direction)."

10. General system information

Notification of freeway junction

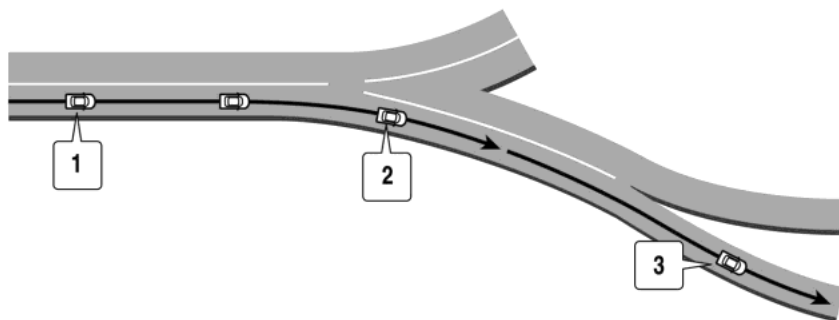

1. "In about one mile (1.6 kilometers), keep to the right (left) onto (road number and direction), then in about one quarter mile (400 meters) keep to the right (left)."
2. "Keep to the right (left) onto (road number and direction), then in about one quarter mile (400 meters) keep to the right (left) onto (road number and direction)."
3. "Keep to the right (left) onto (road number and direction)."

Notification of freeway exit

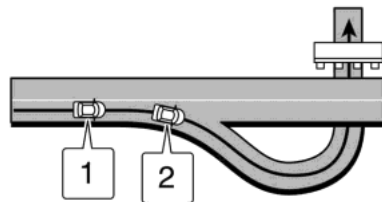

1. "In about one mile (1.6 kilometers), exit on your right."
2. "Take the exit on your right."

Notification when approaching destination

Ordinary road:

When approaching the destination, voice guidance will announce, "You have arrived at your destination. Ending route guidance." To finally reach your destination, refer to the map screen.

Dark green road:

After passing the last turning point on a suggested route, voice guidance will announce, "The route to your destination includes roads through incomplete map areas. Voice guidance will not be provided

in these areas.” When approaching the endpoint of the suggested road, voice guidance will announce, “Entering the road with incomplete map data. Please use the direction arrow and distance information to proceed to your destination.”

REPEATING VOICE GUIDANCE

This function is available throughout route guidance, from the time after the route calculation is completed until the vehicle arrives at the destination. Push **<VOICE>**. Voice guidance will be repeated.



INFO:

- If **<VOICE>** is pushed when the vehicle is deviating from the suggested route and when the automatic reroute function is off, voice guidance will announce, “Proceed to the highlighted route.”
- If **<VOICE>** is pushed when the vehicle is going in the wrong direction, voice guidance will announce: “Please make a legal U-turn if possible.”

NOTES ON VOICE GUIDANCE

- Voice guidance in this system should be regarded as a supplementary function. When driving the vehicle, check the route on the map and follow the actual roads and traffic regulations.
- Voice guidance is activated only for intersections with certain conditions. There may be cases that the vehicle has to turn, but voice guidance is not provided.
- Voice guidance contents may vary, depending on the direction of the turn and the type of intersection.
- The voice guidance timing will vary depending on the situation.
- When the vehicle has deviated from the suggested route, voice guidance is not available. The system will not announce this. Refer to the map and recalculate the route.
 “Recalculate route” (page 5-22)
- Voice guidance may not accurately correspond with road numbers and directions at freeway junctions.
- Voice guidance may not accurately correspond to street names at freeway

exits.

- The displayed street names may sometimes differ from the actual names, or “UNKNOWN STREET NAME” may be displayed.
- Voice guidance is not available when the [Guidance Voice] is turned off.
 “Turning voice guidance ON/OFF” (page 2-25)
- Voice guidance will start when the vehicle enters the suggested route. Refer to the map for directions to the starting point of the route.
- When approaching a waypoint, voice guidance will announce, “You have arrived at waypoint 1 (2, 3, 4,...).” Voice guidance will switch to the next section of the route. When voice guidance is not available, refer to the map for directions.
- In some cases, voice guidance ends before arrival at the destination. Refer to the destination icon on the map to reach the destination.
- If the system recognizes on which side the destination (waypoint) is located, voice guidance will announce “on the

10. General system information

right/left” after announcing the arrival at the destination.

- Voice guidance may be partially operational or inoperative due to the angle of roads at an intersection.
- Because freeway lane information is available only for approximately 7,000 major freeways in North America, it is not possible to display information for all junctions and exits.
- Freeway exit information may differ from the information on the actual exit signs.
- Because it is not possible to consider data concerning roads that are seasonally available or unavailable, a route may be displayed that does not match the actual traffic restrictions. Be sure to follow the actual traffic restrictions while driving.
- Canada and Alaska contain many roads with incomplete map data. As a result, when searching for a route, the route may include roads with incomplete data. In regions where road data is not complete, voice guidance may stop for long periods of time. Be sure to follow the actual traffic restrictions

while driving.

NOTES ON NavTraffic INFORMATION

- The NavTraffic information service is not provided for some cities. In addition, the cities for which the traffic information service is provided may be changed.
- In some cases, infrastructure problems may prevent the complete display of the traffic information. This is not a malfunction.
- Due to infrastructure problems, or due to the time when the traffic information service broadcast is received, the displayed information may differ from the actual traffic conditions.
- Depending on the traffic information, a detour route may be slower than the original route.
- NavTraffic is a service of SiriusXM Satellite Radio. NavTraffic is only available in select markets and is subject to data availability. Reception of the SiriusXM signal may vary depending on location. It requires a monthly premium subscription. The service provider is solely responsible for the quality and accuracy of the information

provided. All fees and programming are subject to change. For more details on the NavTraffic service, terms and conditions, please visit

www.siriusxm.com/navtraffic.

You can also contact SiriusXM Satellite Radio at 1-866-635-2349.

- As of January 31, 2009, the NavTraffic service covers 80 major metropolitan markets. For the most current list of markets covered, please refer to www.siriusxm.com/navtraffic, or call SiriusXM Satellite Radio customer support at 1-866-635-2349.
- Due to road maintenance, infrastructure problems (e.g. malfunction of road sensors, outage of central computer of infrastructure) or natural disasters, there are times when some or all traffic information may not be available.
- Incident information is based on human collection. Not all incidents that have happened are collected and provided.
- Due to infrastructure problems, or transmission delay, there are times when the information may differ from the actual condition. Always observe

safe driving practices and follow all traffic regulations.

- Due to the coverage and quality of traffic information and road conditions, it is not always possible for the system to provide the shortest time route even when traffic information is considered.
- Traffic information that is displayed may differ from information from other media (e.g., radio), as other media may use different information sources.
- If the Infiniti Connection (if so equipped) Text-to-Speech function is used after downloading information feeds immediately after the navigation system is started up, it may take some time until the NavTraffic information is displayed on the screen.

NOTES ON NavWeatherXM INFORMATION

- The NavWeatherXM information service is not provided for some cities. In addition, the cities for which the weather information service is provided may be changed.
- In some cases, infrastructure problems may prevent the complete display of the weather information. This is not a malfunction.
- Due to infrastructure problems, or due to the time when the weather information service broadcast is received, the displayed information may differ from the actual weather conditions.
- NavWeatherXM is a service of SiriusXM Satellite Radio. NavWeatherXM is only available in select markets and is subject to data availability. Reception of the SiriusXM signal may vary depending on location. It requires a monthly premium subscription. The service provider is solely responsible for the quality and accuracy of the information provided. All fees and programming are subject to change.

10. General system information

For more details on the NavWeatherXM service, terms and conditions, please visit

www.siriusxm.com/navweather.

You can also contact SiriusXM Satellite Radio at 1-866-635-2349.

- NavWeatherXM is designed to provide real-time weather and forecasting information in your general vicinity. Discrepancies may be encountered between the system and your actual location. Road system and weather changes may affect the accuracy of the information provided. Rely on your common sense to decide whether to follow a specified route. Detailed coverage is not available in every city or roadway.

MAP DATA

HOW TO ORDER MAP DATA UPDATES

To order updated map data, contact the INFINITI NAVIGATION SYSTEM HELPDESK. See the contact information on the inside front cover of this manual.

ABOUT MAP ICONS

The marks of companies displayed by this product to indicate business locations are the marks of their respective owners. The use of such marks in this product does not imply any sponsorship, approval, or endorsement by such companies of this product.

ABOUT MAP DATA

1. This map data has been prepared by Hitachi Automotive Systems, Ltd. under licence from ZENRIN CO., LTD. and HERE. ZENRIN CO., LTD. has added, processed and digitized data based on the digital road map data of Navigation Technologies Corporation. Due to the production timing of the map data, some new roads may not be included in this map data or some of the names or roads may be different from those at

the time you use this map data.

2. Traffic control and regulation data used in this map data may be different from those at the time you use this map data due to the data production timing. When driving your vehicle, follow the actual traffic control signs and notices on the roads.
3. Reproducing or copying this map software is strictly prohibited by law.

Published by NISSAN North America, Inc.

© 2006 Navigation Technologies. All rights reserved.

Certain business data provided by infogroup ©2010, All Rights Reserved.

© 1993-2008 HERE. All Rights Reserved.

© 2008, All Rights Reserved.

© ZENRIN CO., LTD. 2009. All rights reserved.

© ZENRIN USA, INC. 2008. All rights reserved.

© 2008 Zagat Survey, LLC.



WARNING

- This navigation system should not be used to replace your own judgement. No itinerary suggested by this navigation system should ever override any highway regulations, your own judgement, or a knowledge of safe driving practices. Do not follow the navigation system's suggested itinerary if it would cause you to perform a dangerous or illegal act, place you in a dangerous situation, or take you into an area you consider unsafe.
- The advice provided by the navigation system is to be regarded as a suggestion only. There may be times when the navigation system displays the vehicle's location incorrectly, fails to suggest the shortest route, or fails to direct you to the your desired destination. In such instances, rely on your own driving judgement, taking into account the driving conditions at the time.
- Do not use the navigation system to locate emergency services. The database does not contain a complete listing of emergency services such as police stations, fire halls, hospitals and walk-in clinics. Please show discretion and ask

for directions in such instances.

- As the driver, you alone are responsible for your driving safety.
 - In order to avoid a traffic accident, do not operate the system while driving.
 - In order to avoid a traffic accident, operate the system only when the vehicle is stopped at a safe place and the parking brake is on.
 - In order to avoid a traffic accident or traffic offence, remember that actual road conditions and traffic regulations take precedence over the information contained on the navigation system.
 - The Software may contain inaccurate or incomplete information due to the passage of time, changing circumstances, and the sources of information used. Please respect current traffic conditions and regulations at all times while driving.
 - Where actual road conditions and highway regulations differ from the information contained on the navigation system, abide by the highway regulations.

- Keep the amount of time spent viewing the screen while driving to a strict minimum.

The navigation system does not provide, nor represent in any way information on: traffic and highway regulations; technical aspects of the vehicle including weight, height, width, load and speed limits; road conditions including grade, percentage of incline and surface conditions; obstacles such as the height and width of bridges and tunnels; and other current driving or road conditions. Always rely on your own judgement when driving a car, taking into account current driving conditions.

The marks of companies displayed by this product to indicate business locations are the marks of their respective owners. The use of such marks in this product does not imply any sponsorship, approval, or endorsement by such companies of this product.

10. General system information

END-USER TERMS

The data (“Data”) is provided for your personal, internal use only and not for resale. It is protected by copyright, and is subject to the following terms and conditions which are agreed to by you, on the one hand, and Hitachi Automotive Systems, Ltd. and its licensors (including their licensors and suppliers) on the other hand.

© 2008 HERE. All rights reserved.

The Data for areas of Canada includes information taken with permission from Canadian authorities, including: © Her Majesty the Queen in Right of Canada, © Queen’s Printer for Ontario, © Canada Post Corporation, GeoBase®.

HERE holds a non-exclusive license from the United States Postal Service® to publish and sell ZIP+4® information.

© United States Postal Service® 2008. Prices are not established, controlled or approved by the United States Postal Service®. The following trademarks and registrations are owned by the USPS: United States Postal Service, USPS, and ZIP+4.

The Data may include or reflect data of licensors, including Her Majesty the Queen

in the Right of Canada (“Her Majesty”), Canada Post Corporation (“Canada Post”) and the Department of Natural Resources Canada (“NRCan”). Such data is licensed on an “as is” basis. The licensors, including Her Majesty, Canada Post and NRCan, make no guarantees, representations or warranties respecting such data, either express or implied, arising by law or otherwise, including but not limited to, effectiveness, completeness, accuracy or fitness for a particular purpose.

The licensors, including Her Majesty, Canada Post and NRCan, shall not be liable in respect of any claim, demand or action, irrespective of the nature of the cause of the claim, demand or action alleging any loss, injury or damages, direct or indirect, which may result from the use or possession of the data or the Data. The licensors, including Her Majesty, Canada Post and NRCan, shall not be liable in any way for loss of revenues or contracts, or any other consequential loss of any kind resulting from any defect in the data or the Data.

End User shall indemnify and save harmless the licensors, including Her Majesty, Canada Post and NRCan, and their officers, employees and agents from and against

any claim, demand or action, irrespective of the nature of the cause of the claim, demand or action, alleging loss, costs, expenses, damages or injuries (including injuries resulting in death) arising out of the use or possession of the data or the Data.

Terms and conditions

Personal Use Only. You agree to use this Data together with Nissan Automotive Products for the solely personal, non-commercial purposes for which you were licensed, and not for service bureau, time-sharing or other similar purposes. Accordingly, but subject to the restrictions set forth in the following paragraphs, you may copy this Data only as necessary for your personal use to (i) view it, and (ii) save it, provided that you do not remove any copyright notices that appear and do not modify the Data in any way. You agree not to otherwise reproduce, copy, modify, decompile, disassemble or reverse engineer any portion of this Data, and may not transfer or distribute it in any form, for any purpose, except to the extent permitted by mandatory laws. Multi-disc sets may only be transferred or sold as a complete set as provided by Hitachi Automotive Systems, Ltd. and not as a subset thereof.

Restrictions. Except where you have been specifically licensed to do so by Hitachi Automotive Systems, Ltd., and without limiting the preceding paragraph, you may not (a) use this Data with any products, systems, or applications in-

stalled or otherwise connected to or in communication with vehicles, capable of vehicle navigation, positioning, dispatch, real time route guidance, fleet management or similar applications; or (b) with or in communication with any positioning devices or any mobile or wireless-connected electronic or computer devices, including without limitation cellular phones, palmtop and handheld computers, pagers, and personal digital assistants or PDAs.

Warning. The Data may contain inaccurate or incomplete information due to the passage of time, changing circumstances, sources used and the nature of collecting comprehensive geographic data, any of which may lead to incorrect results.

No Warranty. This Data is provided to you "as is," and you agree to use it at your own risk. Hitachi Automotive Systems, Ltd. and its licensors (and their licensors and suppliers) make no guarantees, representations or warranties of any kind, express or implied, arising by law or otherwise, including but not limited to, content, quality, accuracy, completeness, effectiveness, reliability, fitness for a particular purpose, usefulness, use or results to be

obtained from this Data, or that the Data or server will be uninterrupted or error-free.

Disclaimer of Warranty: HITACHI AUTOMOTIVE SYSTEMS, LTD. AND ITS LICENSORS (INCLUDING THEIR LICENSORS AND SUPPLIERS) DISCLAIM ANY WARRANTIES, EXPRESS OR IMPLIED, OF QUALITY, PERFORMANCE, MERCHANTABILITY, FITNESS FOR A PARTICULAR PURPOSE OR NONINFRINGEMENT. Some States, Territories and Countries do not allow certain warranty exclusions, so to that extent the above exclusion may not apply to you.

Disclaimer of Liability: HITACHI AUTOMOTIVE SYSTEMS, LTD. AND ITS LICENSORS (INCLUDING THEIR LICENSORS AND SUPPLIERS) SHALL NOT BE LIABLE TO YOU: IN RESPECT OF ANY CLAIM, DEMAND OR ACTION, IRRESPECTIVE OF THE NATURE OF THE CAUSE OF THE CLAIM, DEMAND OR ACTION ALLEGING ANY LOSS, INJURY OR DAMAGES, DIRECT OR INDIRECT, WHICH MAY RESULT FROM THE USE OR POSSESSION OF THE INFORMATION; OR FOR ANY LOSS OF PROFIT, REVENUE, CONTRACTS OR SAVINGS, OR ANY OTHER DIRECT, INDIRECT, INCIDENTAL, SPECIAL OR CONSEQUENTIAL DAMAGES ARISING OUT OF YOUR USE OF OR INABILITY TO USE THIS INFORMATION,

10. General system information

ANY DEFECT IN THE INFORMATION, OR THE BREACH OF THESE TERMS OR CONDITIONS, WHETHER IN AN ACTION IN CONTRACT OR TORT OR BASED ON A WARRANTY, EVEN IF HITACHI AUTOMOTIVE SYSTEMS, LTD. OR ITS LICENSORS HAVE BEEN ADVISED OF THE POSSIBILITY OF SUCH DAMAGES. Some States, Territories and Countries do not allow certain liability exclusions or damages limitations, so to that extent the above may not apply to you.

Export Control. You agree not to export from anywhere any part of the Data provided to you or any direct product thereof except in compliance with, and with all licenses and approvals required under, applicable export laws, rules and regulations.

Entire Agreement. These terms and conditions constitute the entire agreement between Hitachi Automotive Systems, Ltd. (and its licensors, including their licensors and suppliers) and you pertaining to the subject matter hereof, and supersedes in their entirety any and all written or oral agreements previously existing between us with respect to such subject matter.

Governing Law. The above terms and conditions shall be governed by the laws

of the State of Illinois, without giving effect to (i) its conflict of laws provisions, or (ii) the United Nations Convention for Contracts for the International Sale of Goods, which is explicitly excluded. You agree to submit to the jurisdiction of the State of Illinois for any and all disputes, claims and actions arising from or in connection with the Data provided to you hereunder.

Government End Users. If the Data is being acquired by or on behalf of the United States government or any other entity seeking or applying rights similar to those customarily claimed by the United States government, HERE Data (hereinafter "Data") is a "commercial item" as that term is defined at 48 C.F.R. ("FAR") 2.101, is licensed in accordance with ENDUSER TERMS, and each copy of the Data delivered or otherwise furnished shall be marked and embedded as appropriate with the following "Notice of Use," and shall be treated in accordance with such Notice:

<p style="text-align: center;">NOTICE OF USE CONTRACTOR (MANUFACTURER/SUPPLIER) NAME: HERE CONTRACTOR (MANUFACTURER/SUPPLIER) ADDRESS: 425 West Randolph St., Chicago, Illinois 60606 This Data is a commercial item as defined in FAR 2.101 and is subject to END-USER TERMS under which this Data was provided. © 2008 HERE - All rights reserved.</p>

If the Contracting Officer, federal government agency, or any federal official refuses to use the legend provided herein, the Contracting Officer, federal government agency, or any federal official must notify HERE prior to seeking additional or alternative rights in the Data.

HOW TO HANDLE DISPLAY

The display is a liquid crystal display and should be handled with care.



WARNING

Never disassemble the display. Some parts utilize extremely high voltage. Touching them may result in serious personal injury.

CHARACTERISTICS OF LIQUID CRYSTAL DISPLAY

- If the temperature inside the vehicle is especially low, the display will stay relatively dim or the movement of the images may be slow. These conditions are normal. The display will function normally when the interior of the vehicle has warmed up.
- Some pixels in the display are darker or brighter than others. This condition is an inherent characteristic of liquid crystal displays, and it is not a malfunction.
- A remnant of the previous display image may remain on the screen. This screen burn is inherent in displays, and

it is not a malfunction.



INFO:

The screen may become distorted by strong magnetic fields.

MAINTENANCE OF DISPLAY



WARNING

- To clean the display, never use a rough cloth, alcohol, benzine, thinner and any kind of solvent or paper towel with a chemical cleaning agent. They will scratch or deteriorate the panel.
- Do not splash any liquid such as water or car fragrance on the display. Contact with liquid will cause the system to malfunction.

To clean the display screen, use a dry, soft cloth. If additional cleaning is necessary, use a small amount of neutral detergent with a soft cloth. Never spray the screen with water or detergent. Dampen the cloth first, then wipe the screen.

10. General system information

MEMO

11 Troubleshooting guide

Customer assistance	11-2	Voice guidance	11-8
Basic operations	11-3	Infiniti Connection™ (if so equipped).....	11-9
Vehicle icon.....	11-4	Voice recognition	11-10
Route calculation and visual guidance.....	11-6	Traffic information	11-11



11. Troubleshooting guide

CUSTOMER ASSISTANCE



For assistance or inquiries about the INFINITI Navigation System, contact the INFINITI NAVIGATION SYSTEM HELPDESK. See the contact information on the inside front cover of this manual.

BASIC OPERATIONS

Symptom	Possible cause	Possible solution
No image is displayed.	The brightness is at the lowest setting.	Adjust the brightness of the display.
	The system is in the video mode.	Push the appropriate button (depending on models) on the control panel to change the mode. Refer to the vehicle Owner's Manual.
	The display is turned off.	Push <DAY/NIGHT OFF> to turn on the display.
No voice guidance is available. or The volume is too high or too low.	The volume is not set correctly, or it is turned off.	Adjust the volume of voice guidance.
	Voice guidance is not provided for certain streets (roads displayed in gray).	This is not a malfunction.
No map is displayed on the screen.	A screen other than map screen is displayed.	Push <MAP>.
The screen is too dim. The movement is slow.	The temperature in the interior of the vehicle is low.	Wait until the interior of the vehicle has warmed up.
Some pixels in the display are darker or brighter than others.	This condition is an inherent characteristic of liquid crystal displays.	This is not a malfunction.
Some menu items cannot be selected.	Some menu items become unavailable while the vehicle is driven.	Park the vehicle in a safe location, and then operate the navigation system.

11. Troubleshooting guide

VEHICLE ICON

Symptom	Possible cause	Possible solution
Names of roads and locations differ between Plan View and Birdview™.	This is because the quantity of the displayed information is reduced so that the screen does not become too crowded. There is also a chance that names of the roads or locations may be displayed multiple times, and the names appearing on the screen may be different because of a processing procedure.	This is not a malfunction.
The vehicle icon is not displayed in the correct position.	The vehicle was transported after the ignition switch was pushed off, for example, by a ferry or car transporter.	Drive the vehicle for a while on a road where GPS signals can be received.
	The position and direction of the vehicle icon may be incorrect depending on the driving environments and the levels of positioning accuracy of the navigation system.	This is not a malfunction. Drive the vehicle for a while to automatically correct the position and direction of the vehicle icon.  "Current vehicle location" (page 10-4)
When the vehicle is traveling on a new road, the vehicle icon is located on another road nearby.	Because the new road is not stored in the map data, the system automatically places the vehicle icon on the nearest road available.	Updated road information will be included in the next version of the map data.
The screen does not switch to the night screen even after turning on the headlights.	The daytime screen was set the last time the headlights were turned on.	Set the screen to the night screen mode using <DAY/NIGHT OFF> when turning on the headlights.  "Display settings" (page 8-3)
The map does not scroll even when the vehicle is moving.	The current location map screen is not displayed.	Push <MAP> .
The vehicle icon is not displayed.	The current location map screen is not displayed.	Push <MAP> .

11. Troubleshooting guide

Symptom	Possible cause	Possible solution
The GPS indicator on the screen remains gray.	GPS signals cannot be received under certain conditions, such as in a parking garage, on a road with many tall buildings, etc.	Drive on an open, straight road for a while.
	GPS signals cannot be received because objects are placed on the instrument panel.	Remove the objects from the instrument panel.
	A sufficient number of GPS satellites is not available.	Wait for the satellites to move to locations available for the navigation system.
The location of the vehicle icon is misaligned from the actual position.	When using tire chains or replacing the tires, speed calculations based on the speed sensor may be incorrect.	Drive the vehicle for about 30 minutes at approximately 19 MPH (30 km/h) to automatically correct the vehicle icon position. If this does not correct the vehicle icon position, contact an INFINITI retailer.
	The map data has a mistake or is incomplete (the vehicle icon position is always misaligned in the same area).	Updated road information will be included in the next version of the map data.

11. Troubleshooting guide

ROUTE CALCULATION AND VISUAL GUIDANCE

Symptom	Possible cause	Possible solution
Waypoints are not included in the auto reroute calculation.	Waypoints that have been already passed are not included in the auto reroute calculation.	To go to that waypoint again, edit the route.
Route information is not displayed.	Route calculation has not yet been performed.	Set the destination and perform route calculation.
	The vehicle is not on the suggested route.	Drive on the suggested route.
	Route guidance is set to off.	Turn on route guidance.
	Route information is not provided for certain types of roads (roads displayed in gray).	This is not a malfunction.
The auto reroute calculation (or detour calculation) suggests the same route as the one previously suggested.	Route calculations took priority conditions into consideration, but the same route was calculated.	This is not a malfunction.
A waypoint cannot be added.	Five waypoints are already set on the route, including ones that the vehicle has already passed.	A maximum of 5 waypoints can be set on the route. To go to 6 or more waypoints, perform route calculations multiple times as necessary.
	[Calculate] must be selected for route calculation after Waypoints are selected from the "Edit/Add to Route" screen.	Highlight [Calculate] and push <ENTER> after selecting waypoints.

11. Troubleshooting guide

Symptom	Possible cause	Possible solution
The suggested route is not displayed.	Roads near the destination cannot be calculated.	Reset the destination to a main or ordinary road, and recalculate the route.
	The starting point and destination are too close.	Set a more distant destination.
	The starting point and destination are too far away.	Divide the trip by selecting one or two intermediate destinations, and perform route calculations multiple times.
	There are time restricted roads (by the day of the week, by time) near the current vehicle location or destination.	Set [Use Time Restricted Roads] to off.  "Setting conditions for route calculation" (page 5-25)
A part of the route is not displayed.	The suggested route includes narrow streets (roads displayed in gray).	This is not a malfunction.
The part of the route that the vehicle has already passed is deleted.	A route is managed by sections between waypoints. If the vehicle passed the first waypoint, the section between the starting point and the waypoint is deleted (it may not be deleted depending on the area).	This is not a malfunction.
An indirect route is suggested.	If there are restrictions (such as one-way streets) on roads close to the starting point or destination, the system may suggest an indirect route.	Adjust the location of the starting point or destination.
	The system may suggest an indirect route because route calculation does not take into consideration some areas such as narrow streets (gray roads).	Reset the destination to a main or ordinary road, and recalculate the route.
The landmark information does not correspond to the actual information.	This may be caused by insufficient or incorrect map data.	Updated information will be included in the next version of the map data.
The suggested route does not exactly connect to the starting point, waypoints, or destination.	There is no data for route calculation closer to these locations.	Set the starting point, waypoints and destination on a main road, and perform route calculation.

11. Troubleshooting guide

VOICE GUIDANCE



Symptom	Possible cause	Possible solution
Voice guidance is not available.	Voice guidance is only available at certain intersections marked with  . In some cases, voice guidance is not available even when the vehicle should make a turn.	This is not a malfunction.
	The vehicle has deviated from the suggested route.	Go back to the suggested route or request route calculation again.
	Voice guidance is set to off.	Turn on voice guidance.
	Route guidance is set to off.	Turn on route guidance.
The guidance content does not correspond to the actual condition.	The content of voice guidance may vary, depending on the types of intersections at which turns are made.	Follow all traffic rules and regulations.

INFINITI CONNECTION™ (if so equipped)

Symptom	Possible cause	Possible solution
The system cannot connect to the Infiniti Connection Data Center.	A subscription for the Infiniti Connection service has not been established.	Sign up for a subscription to the Infiniti Connection service. For details about subscriptions, contact the Infiniti Connection support line at 1-800-334-7858 (for U.S.) /1-855-892-7418 (for Canada).
	The communication line is busy.	Try again after a short period of time.
	The vehicle is in a location where it is difficult to receive radio waves.	When the vehicle moves to an area where radio waves can be transmitted sufficiently, communication will be restored. When the icon on the display shows that the vehicle is inside the communication area, the system can be used.
	TCU (Telematics Communication Unit) is not turned on.	If the icon does not show that the vehicle is inside the communication area despite the fact that the vehicle is in that location, contact the Infiniti Connection support line at 1-800-334-7858 (for U.S.) /1-855-892-7418 (for Canada).
	Radio wave reception is not sufficient for TCU operation.	When the vehicle moves to an area where radio waves can be transmitted sufficiently, communication will be restored. When the icon on the display shows that the vehicle is inside the communication area, the system can be used.
Some of the items that are displayed on the menu screen cannot be selected.	The vehicle is being driven and some menu items are disabled.	The vehicle is being driven. Stop the vehicle in a safe location and apply the parking brake before operating the functions.
Some parts of the screen are not displayed.	The vehicle is being driven and some menu items are disabled.	Operate the system after stopping the vehicle in a safe location and applying the parking brake.
The system does not announce information.	The volume level is set to the minimum.	Adjust the volume level by operating the VOLUME control knob located on the control panel or on the steering wheel switch while the system is announcing information.

11. Troubleshooting guide

VOICE RECOGNITION

Symptom	Possible cause	Possible solution
The system does not accept the voice command. or The system accepts the voice command incorrectly.	The interior of the vehicle is too noisy.	Close the windows or have other occupants be quiet.
	The volume of the voice is too low.	Speak louder.
	The volume of the voice is too loud.	Speak softer.
	Pronunciation is unclear.	Speak clearly.
	The voice command is given before the voice recognition system is ready.	Push ◀TALK  on the steering wheel, and speak a command after the tone sounds.
	8 seconds or more have passed after pushing ◀TALK  on the steering wheel.	Make sure to speak a command within 8 seconds after the beep tone sounds.
	Only a limited range of voice commands is usable for each screen.	Use a correct voice command appropriate for the current screen.
The system cannot be operated.	The retractable hard top is not closed (G37 Convertible only).	Close the retractable hard top.



INFO:

For the best recognition, speak the appropriate commands. Command lists are available earlier in this manual.



Standard Mode:

 “Command lists (Standard mode)”
(page 9-20)

Alternate Command Mode:

 “Command Lists (Alternate command mode)” (page 9-23)

TRAFFIC INFORMATION

Symptom	Possible cause	Possible solution
The traffic information is not displayed.	The traffic information is not set to on.	Set the traffic information to on.
	The vehicle is in an area where traffic information is not available.	Scroll to an area where traffic information is available.
	The subscription to NavTraffic is incomplete, or the subscription to NavTraffic has expired.	Check the subscription status of NavTraffic.
	The map scale is set at a level where the display of icons is impossible.	Check that the map scale is set at a level in which the display of icons is possible.  “Traffic information display and scale levels” (page 7-20)
With the automatic detour route search ON, no detour route is set to avoid congested areas.	There is no faster route compared to the current route, based on the road network and traffic information.	The automatic detour search is not intended for avoiding traffic jams. It searches for the fastest route taking into consideration such things as traffic jams. Follow the current route. Also see “Notes on NavTraffic information” for further information.  “Notes on NavTraffic information” (page 10-14)
The route does not avoid a road section with traffic information stating that it is closed due to road construction.	The navigation system is designed not to avoid this event because the actual period of closure may differ from the declared roadwork period.	Observe the actual road conditions and follow the instructions on the road for detour when necessary. If the road actually is closed, use the detour function and set the detour distance to avoid the road section that is closed.

11. Troubleshooting guide

MEMO

CURRENT LOCATION MAP SCREEN

◀ENTER▶	Store Location		page 6-2	
	Nearby Places		page 4-6	
	Map View	Change View	2D Map	page 3-11
			Split: 2D Map	page 3-11
			Birdview (3D)	page 3-11
			Split: Birdview Map	page 3-11
		View Settings	Intersection	page 5-10
			Turn List	page 5-10
			Fuel Economy	page 5-10
			Full Map	page 5-10
		Map Settings	Map Orientation	page 3-14
			Long Range	page 3-15
			Map Color	page 3-16
			Birdview Angle	page 3-16
			Left Split Map Settings	page 3-17

Index

◀ENTER▶	Map View	Map Settings	Show All Freeway Exits on Route	page 5-11
			Auto. Show Turn List on Freeway	page 5-11
	Map Icons	Restaurant	page 3-18	
		Gas Station	page 3-18	
		Hotel	page 3-18	
		ATM	page 3-18	
		Rest Area	page 3-18	
	Store Tracking	page 6-6		

SCROLL LOCATION MAP SCREEN

◀ENTER▶	New Dest.	Start	page 5-2
		More Routes	page 5-3
		Add/Route Info	page 5-3
		Move Location	page 5-5
		Store Location	page 5-5
		Place Info	page 5-6
	Add to Route	page 5-15	
	Nearby Places	page 4-6	
	Store Location	page 6-2	
	Delete	page 6-20	
Incident Detail	page 7-20		

DESTINATION SCREEN

◀DEST▶	Change Region	page 4-3	
	Street Address	page 4-4	
	Places	page 4-6	
	Home	page 4-11	
	Address Book	page 4-12	
	Previous Destinations	page 4-13	
	Connected Search (if soequipped)	page 4-14	
	Next Page	Delete Destination	page 4-24
		Previous Start Point	page 4-16
		Stored Routes	page 4-17
		Phone Number	page 4-18
Freeway Entrance/Exit		page 4-19	
Intersection		page 4-20	
	City Center	page 4-22	

ROUTE SCREEN

◀ROUTE▶	Cancel Route/Resume Route		page 5-14
	Edit/Add to Route		page 5-15
	Route Info		page 5-20
	Guidance Settings	Guidance Voice	page 5-21
		Guidance Volume	page 5-21
		Traffic Announcement	page 5-21
	Recalculate		page 5-22
	Detour		page 5-23
	Traffic Detour		page 5-24
	Route Settings	Basic Route Type	page 5-25
		Other Routing Choices	page 5-26

SETTING SCREEN

◀SETTING▶	Navigation	Address Book	page 6-8
		Map View	page 3-13
		Map Icons	page 3-18
		Guidance Settings	page 5-27
		Route Settings	page 5-26
		Traffic Info Settings	page 7-20
		Weather Info Settings	page 7-29
		Speed Limit Info	page 8-6
		Others	page 8-7
		Delete Stored Information	page 8-10
		Delete Connected Search History (if so equipped)	page 8-10
		Delete All Previous Destinations	page 8-10
		Delete All Previous Start Point	page 8-10
		Reset All Navigation Settings to Default	page 8-10

◀SETTING▶	Audio	Vehicle Owner's Manual	
	Phone	Vehicle Owner's Manual	
	Bluetooth	Vehicle Owner's Manual	
	Volume & Beeps	page 8-11	
	ECO DRIVE	Vehicle Owner's Manual	
	Driver Assistance	Vehicle Owner's Manual	
	Others	Rear Display	Vehicle Owner's Manual
		Display	page 8-3
		Comfort	Vehicle Owner's Manual
		Clock	page 8-12
		Language & Units	page 8-13
		Voice Recognition	page 9-14
		Infiniti Connection™ (if so equipped)	page 7-12
Camera		Vehicle Owner's Manual	
Sonar	Vehicle Owner's Manual		
Image Viewer	Vehicle Owner's Manual		

INFORMATION SCREEN

◀INFO▶	Infiniti Connection (if so equipped)		page 7-3
	Energy Flow		Vehicle Owner's Manual
	Fuel Economy		Vehicle Owner's Manual
	Tire pressure		Vehicle Owner's Manual
	Traffic Info		page 7-15
	Weather Info		page 7-22
	Others	Where am I?	page 7-15
		Maintenance	Vehicle Owner's Manual
		Map Update	page 7-31
		Navigation Version	page 7-32
GPS Position		page 7-32	
	Voice Recognition	 "9. Voice recognition"	

Number

2D map..... 3-2, 3-5

A

About map data..... 10-16

About map icons..... 10-16

About route guidance..... 5-7

Address book..... 10-2

Adjusting voice guidance volume 2-25

Alternate Command Mode..... 9-9

Automatic reroute 10-3

Automatically

display warnings/watches..... 7-29

Avoid area 10-2

B

Basic operations (Troubleshooting) 11-3

Basics of voice guidance..... 10-10

Before starting..... 2-27, 9-4, 9-13

Birdview™ 10-3

Birdview™ (3D) map 3-3, 3-7

Building graphics..... 3-3

C

Canceling route..... 2-23

Canceling/reactivating route 5-14

Changing Birdview™ angle 3-16

Changing map view..... 3-11

Changing region 4-3

Changing scale of map..... 3-8

Character (letters and numbers)

input screen..... 2-16

Characteristics of liquid crystal display .. 10-21

Clock settings 8-12

Command Lists (Alternate

command mode) 9-23

Command lists (Standard mode) 9-20

Confirming how to use

voice commands 9-2, 9-10

Confirming route 5-3, 5-20

Connecting to Interactive Voice Menu..... 7-11

Control buttons and functions 2-2

Control panel (Type A)..... 2-2

Control panel (Type B)..... 2-3

Control Panel (Type C)..... 2-5

Current location map screen 2-18

Current vehicle location 10-4

Customer assistance (Troubleshooting) ... 11-2

Customizing Nearby Places 8-8

D

Delete destination..... 4-24

Delete stored items..... 8-10

Deleting all stored items 6-20

Deleting individual item on map 6-20

Deleting Infiniti Connection history 7-12

Deleting stored item 6-19

Deleting stored item individually..... 6-19

Destination screen 4-2

Destination weather on suggested

route screen 7-28

Detailed Map Coverage Areas (MCA) for

navigation system..... 10-7

Detour 10-3

Directions provided and distances to

guide points 10-10

Display adjustment 8-3

Display of current vehicle location 10-4

Display settings 8-3

Display urgent traffic information 7-18

Displaying current vehicle location..... 3-4

Displaying how to operate voice

recognition system..... 9-9

Displaying map icons..... 3-18

Displaying small turn arrow on map..... 5-29

Displaying unit ID information..... 7-13

Index

Displaying weather information screen.... 7-23

E

Editing address book 6-8
Editing avoid area 6-16
Editing route 5-15
Editing stored home and address..... 6-9
Editing stored route 6-14
Editing stored tracking 6-15
Emergency support 7-14
End-user terms 10-18
Example of touch panel operation 2-15

F

Features of this navigation system 10-2
Finding address 4-4
Finding place 4-6
For safe operation 1-2
Functions disabled while driving 2-10

G

Giving voice commands 2-28, 9-4, 9-13
Guidance screen settings 5-9
Guidance screens and preview mode 5-8

Guidance settings 5-21

H

How to handle display 10-21
How to input letters and numbers 2-16
How to order map data updates 10-16
How to store home location 2-20
How to use this manual 1-2
How to view map screen 2-24

I

Incorrect display of vehicle position 10-5
Infiniti Connection feature 7-3
Infiniti Connection service application 7-7
INFINITI controller with
Directional buttons 2-6
INFINITI controller without
Directional buttons 2-6
INFINITI voice recognition 2-27, 9-2
Info on route 7-17
Information feeds 7-9
Information screen 7-2
Initialization 9-4
Initializing all Infiniti Connection 7-13

L

Language and unit settings 8-13
Language settings 8-13
Laser product 1-3
List screen 2-14
Looking at information on map 3-18

M

Maintenance of display 10-21
Map data 10-16
Map menu screen 2-18
Map scale 3-10
Map scrolling information 3-19
Map symbols 3-21
Map types 3-2
Map update 7-31
Map view settings 3-13
Menu screen and operation method 2-11
Menu screens and their purposes 2-11
Minor adjustment of home or
stored address 6-10
Moving location of destination 5-5
Moving map 3-5

N

Navigation setting.....	8-5
Navigation system status screen.....	2-9
NavTraffic information.....	10-2
Nearby traffic Info.....	7-17
Notes on NavTraffic information.....	10-14
Notes on NavWeatherXM information....	10-15
Notes on voice guidance.....	10-13
Number input screen.....	2-17

O

Operating maps.....	2-24
Operating with center dial.....	3-9
Operating with control panel.....	3-4
Operating with touch panel operation.....	3-5, 3-10
Operating with ZOOM buttons.....	3-8
Other navigation settings.....	8-7
Other settings.....	3-12

P

Places of interest (places) directory.....	10-2
Procedures after setting destination.....	5-2

R

Recalculate route.....	5-22
Reference symbols.....	1-2
Repeating voice guidance.....	10-13
Reset all navigation settings to default ...	8-10
Road color.....	3-22
Route calculation.....	10-8
Route calculation and visual guidance (Troubleshooting).....	11-6
Route guidance.....	10-2, 10-10
Route guidance settings.....	5-27
Route screen.....	5-13

S

Safety information.....	1-2
Scrolled location map screen.....	2-19
Searching for destinations.....	2-21
Searching for detour route taking traffic information into consideration.....	5-24
Searching from address book.....	4-12
Selecting route.....	5-3
Set average speeds.....	5-30
Setting alternate command mode.....	9-14
Setting by Infiniti Connection.....	4-14
Setting by phone number.....	4-18

Setting city center.....	4-22
Setting color theme.....	8-5
Setting conditions for route calculation...	5-25
Setting destination.....	2-21
Setting detour route.....	5-23
Setting freeway entrance/exit.....	4-19
Setting from stored routes.....	4-17
Setting home as destination.....	4-11
Setting intersection.....	4-20
Setting left screen display.....	3-17
Setting map color.....	3-16
Setting map orientation.....	3-14
Setting point on map.....	4-23
Setting previous destination.....	4-13
Setting previous start point.....	4-16
Setting voice guidance.....	2-25
Setting voice guidance at intersections...	5-28
Settings keyboard layout of character input screen.....	8-8
Settings long range map view.....	3-15
Settings screen.....	8-2
Speaker adaptation.....	9-15
Speed limit indication on map.....	8-6
Standard mode.....	9-2
Start menu.....	2-13
Starting route guidance.....	2-22, 5-2

Index

Starting system 2-8
Steering wheel switches 2-7
Storing avoid area 6-7
Storing current vehicle location..... 6-3
Storing home location/address 2-20
Storing location 5-5, 6-2
Storing location by moving map..... 6-4
Storing location by searching..... 6-2
Storing route 6-5
Storing tracked route 6-6
Switching estimated arrival time display .. 5-29
System feedback announcement modes .. 9-14

T

Touch panel operation 2-15
Touch screen operation..... 2-11
Traffic information..... 11-11
Traffic information on map 3-22, 7-19
Traffic information settings 7-20
Transferring information to/from
Address Book 6-22
Turning voice guidance ON/OFF..... 2-25

U

Unit settings 8-14

Updating All Information Feeds 7-10
Using controls to adjust values,
levels, etc. 2-12
Using voice
recognition system..... 2-27, 9-4, 9-13

V

Vehicle icon (Troubleshooting) 11-4
Viewing available traffic information 7-16
Viewing available weather information 7-22
Viewing GPS current
location information..... 7-32
Viewing information about current
vehicle location..... 7-15
Viewing information about
searched location 5-6
Viewing information feeds history 7-12
Viewing navigation system
version information 7-32
Voice command examples 9-5, 9-17
Voice guidance 10-3
Voice guidance (Troubleshooting)..... 11-8
Voice guidance during route guidance..... 5-7
Voice recognition (Troubleshooting) 11-10
Volume adjustment 8-11

W

What is GPS (Global
Positioning System)?..... 10-4
When gray road is displayed on map 10-8

